

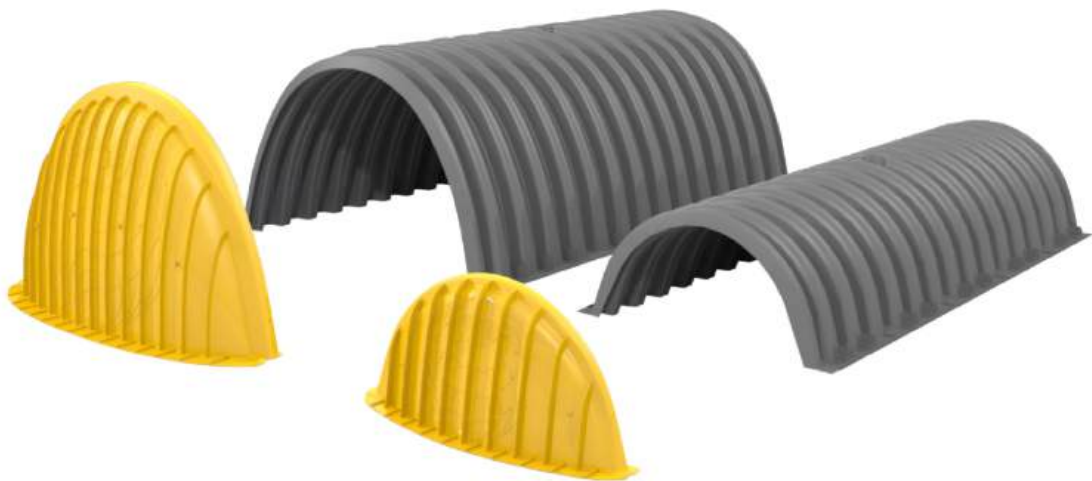

TRICEL
GENERATIONS OF INNOVATION

STORMWATER MANAGEMENT SYSTEMS INSTALLATION GUIDE

Installation Guide



NeroStor NS2 & NS1

Table of Contents

Index of Tables.....	1
Index of Figures.....	1
Introduction.....	2
Chamber Handling and Storage.....	2
Subgrade and Foundation Preparation.....	5
Inlet Manifold Assembly and Chamber Placement.....	8
Chamber Outlet Options.....	11
Pre-treatment / Sediment Row.....	12
Stormwater Quality Unit Option.....	12
Sediment Row Option.....	12
Vent / Inspection Port Placement.....	14
Chamber Backfill Requirements.....	15
Minimum and Maximum Cover Heights.....	18

Index of Tables

Table 1 - Suitable Geotextiles	6
Table 2 - Acceptable Backfill Materials	15
Table 3 - Backfill Placement & Compaction Recommendations*	17
Table 4 - Maximum Allowable Construction Vehicle Loads*	19

Index of Figures

Figure 1 - Chambers on a Truck.....	3
Figure 2 - Minimum 72" (1.8 m) Forks for Unloading Chamber Pallets.....	3
Figure 3 - Chamber Handles.....	4
Figure 4 - Chamber Unloading from Pallets.....	4
Figure 5 - Excavation Footprint for Chambers.....	5
Figure 6 - Filter Fabric Installation.....	6
Figure 7- Foundation Compaction with Plate Compactor.....	7
Figure 8 - Optional Underdrain.....	7
Figure 9 - Inlet Manifold Options.....	8
Figure 10 - Inlet Scour Protection.....	8
Figure 11 - Manifold / End Cap Connection.....	9
Figure 12 - End Cap Assembly.....	9
Figure 13 - Chamber Joint Assembly.....	10
Figure 14 - Minimum Chamber Row Spacing.....	10
Figure 15 - Outlet Manifold Configuration.....	11
Figure 16 - Prinsco Stormwater Quality Unit (SWQU).....	12
Figure 17 - Sediment Row.....	13
Figure 18 - Inspection Ports.....	14
Figure 19 - Chamber Cross Section.....	15
Figure 20 - Backfill Placement with Excavator.....	16
Figure 21 - Embedment Stone Placement.....	16
Figure 22 - Perimeter Backfill Placement.....	16
Figure 23 - Filter Fabric over Top of Chambers.....	17

Introduction

NeroStor stormwater chambers are designed to provide a highly efficient solution for underground water management. NeroStor Chambers are high performance arch shaped chambers designed to rigorous ASTM F2418 and ASTM F2787 requirements. However, as with any buried structure, it is important to follow the guidelines contained herein to ensure structural integrity and maximum service life. In addition, the chamber supplier, chamber installer (site contractor), and the design engineer are encouraged to meet for a pre-construction meeting to discuss any questions relating to the installation process, and the guidelines herein. Below is a checklist of Materials/Equipment that will be typically be needed for each NeroStor chamber system.

- NeroStor Chambers & End Caps
- Woven & Non-woven Geotextiles
- Manifold pipe, fittings & couplers
- Acceptable backfill material found in Table 2
- Pre-treatment System
- Inlet Diversion Structure for sediment row (optional)
- PVC pipe & fittings for inspection port (optional)
- Minimum 72" (1.8 m) forks for unloading NS2 chamber pallets
- Reciprocating saw for coring holes in end caps
- Approved compaction equipment
- Excavator to dig trench and place stone and soil backfill
- Stone conveyor / LGP dozer (CAT[®] D4 or smaller) not exceeding 4.5psi (31 kPa) to grade

Chamber Handling and Storage

Upon delivery to the project site, visually inspect the chambers and end caps to ensure accurate quantities. Any damage that may have occurred during transport should also be noted at this time. Chambers will be marked with either an identification sticker or tag listing the product name, nominal size and the governing standards.

The NS1 chambers will be delivered with up to 45 stacked chambers per pallet and the NS2 chambers with up to 33 stacked chambers on a pallet. Unloading of the NS2 chambers pallets should be done with a forklift with a minimum of 1.8 m forks. Chambers and end caps may remain on the pallets until they are ready to be installed.



Figure 1 - Chambers on a Truck

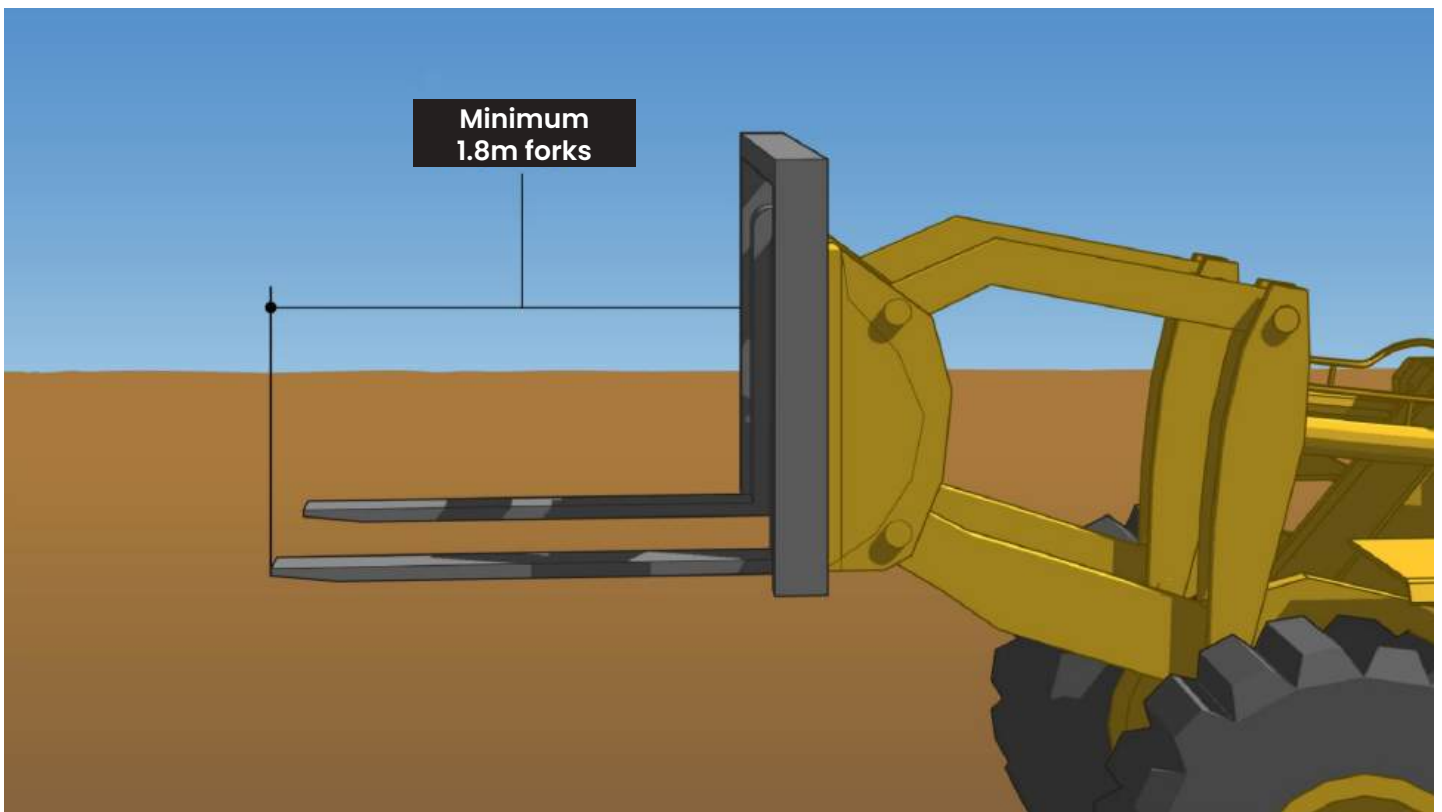

Figure 2 - Minimum 1.8 m Forks for Unloading Chamber Pallets

Chambers should be stored in an area that is flat and free of debris. To avoid the potential for damage, the storage area should be located far enough away from construction traffic to avoid potential contact.

Some NeroStor chambers were designed with the installer in mind and are equipped with handles to allow the chambers to be moved and set in place with ease.

To remove chambers from the pallets, carefully cut and remove the banding from around the chambers. With two people, use the handles on larger chambers to lift the chambers off of the pallet and carry them into place.



Figure 3 - Chamber Handles

WARNING: THE CHAMBERS MUST NOT BE REMOVED FROM THE STACK BY PUSHING THEM OFF FROM ONE SIDE. REMOVING THE CHAMBERS IN THIS MANNER MAY RESULT IN CHAMBER DAMAGE, INJURIES OR EVEN DEATH.

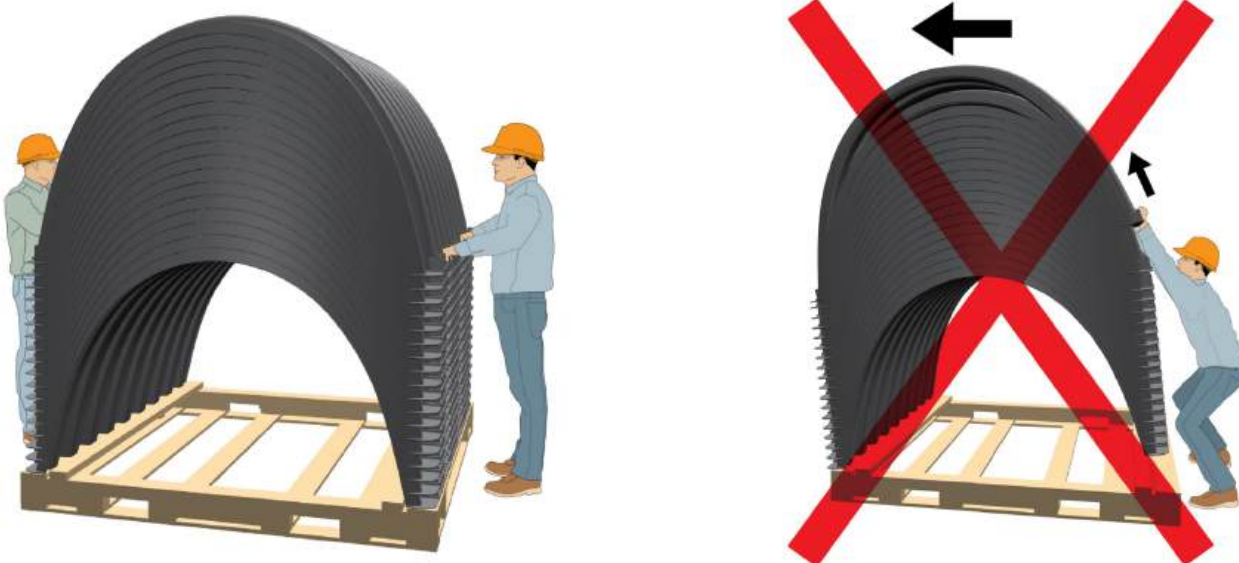

Figure 4 - Chamber Unloading from Pallets

Subgrade and Foundation Preparation

Due to the inherent hazards associated with excavation, special precautions should be taken. All Federal Occupational Safety and Health Administration (OSHA), State and Local safety requirements should be followed.

Using the project plans and the appropriate details, excavate the chamber system bed in a manner to sufficiently accommodate the chambers and manifolds. To ensure an adequate fit, and to allow for a stone border, a minimum of 300 mm of excavation is required between the trench sidewalls and the chamber system.

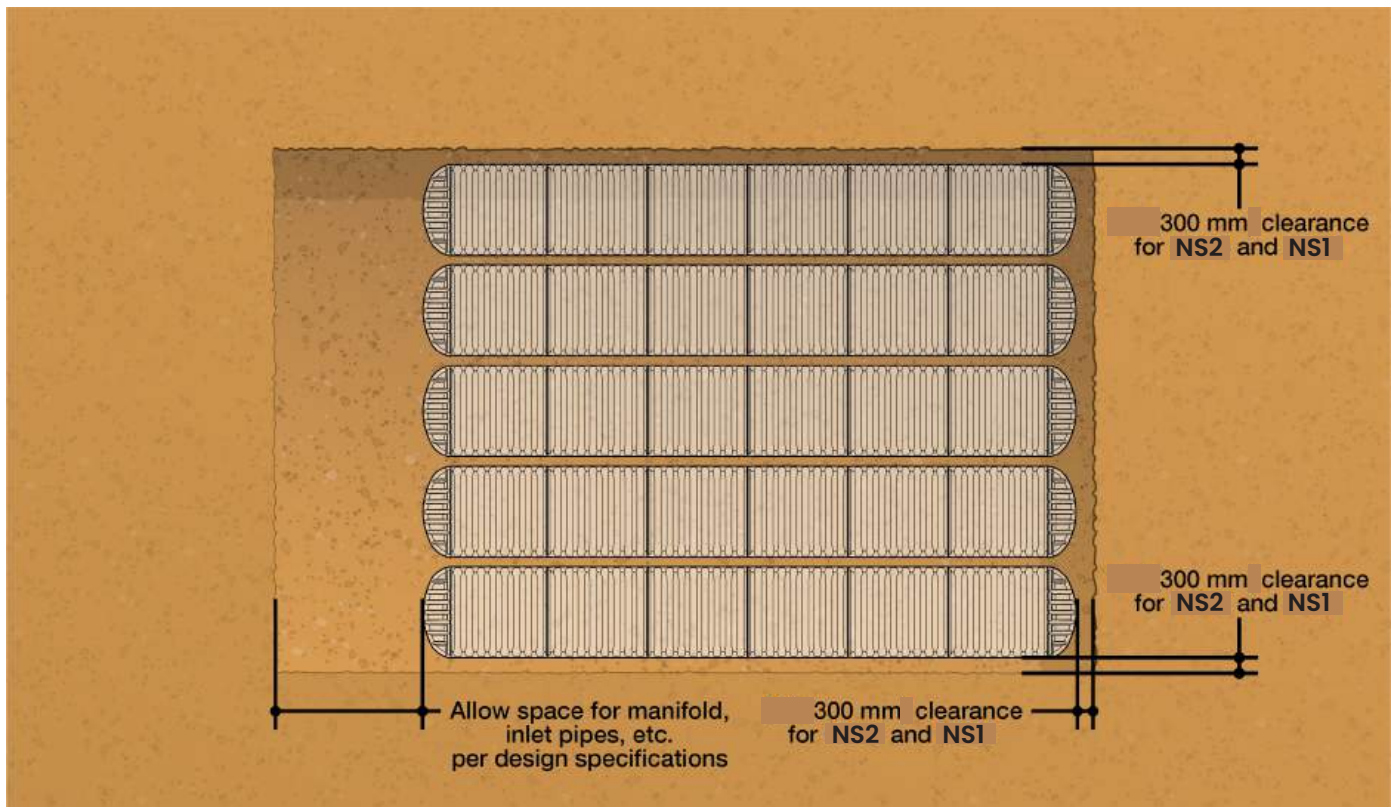

Figure 5 - Excavation Footprint for Chambers

Water within the excavation area should be controlled before and during the chamber installation. If standing water is present, dewatering measures should be utilized. There are many dewatering methods including but not limited to: sump pumps, well points, deep wells, underdrains, and stone blankets. The method of dewatering, if required, shall be selected based on the site conditions and severity of the water.

The NeroStor chambers depend on a stable soil subgrade for support; an unstable subgrade can result in differential settlement or other structural distress. If an unstable subgrade is encountered, it shall be remedied prior to chamber foundation stone placement. There are several methods of improving the subgrade prior to installation depending on the soil conditions present. Consult the design engineer for the desired method based on the site conditions.

- **Reinforce** – Soft soils are reinforced by adding dry soil, stabilizing geotextile or geogrid materials, or lime and then compacting for stabilization.
- **Displace** – Soupy soils are displaced by placing an overburden material such as large aggregate in the bottom until the foundation is consolidated and stabilized.
- **Restore** – Loose soils can be restored by compacting to a greater density.
- **Remove** – Existing soils that are unusable should be completely excavated and replaced with a suitable material.

Upon the prepared subgrade, place an AASHTO M288 Class 2 or Class 3 non-woven geotextile for the separation layer on the bed bottom and up and along the sidewalls. Refer to Table 1 for suitable geotextile options. Alternative geotextile options may be acceptable and should be approved by the design engineer. Maintain a 600 mm overlap of fabric at all seams. Fabric will also be required over top of the system after the embedment stone is placed over the chambers (minimum 6” [150 mm] for NS1 and NS2 chambers).

Table 1 – Geotextile Specifications

Geotextile Specification	Minimum of AASHTO M288 Class 2 or 3 Non-woven Separation & Filtration	AASHTO M288 Class 1 Woven Stabilisation & Scour Protection
Geotextile Placement	Separation Layer between angular stone and in-situ soil to prevent fines intrusion.	Stabilisation Layer under Sediment Row & Scour Protection Layer

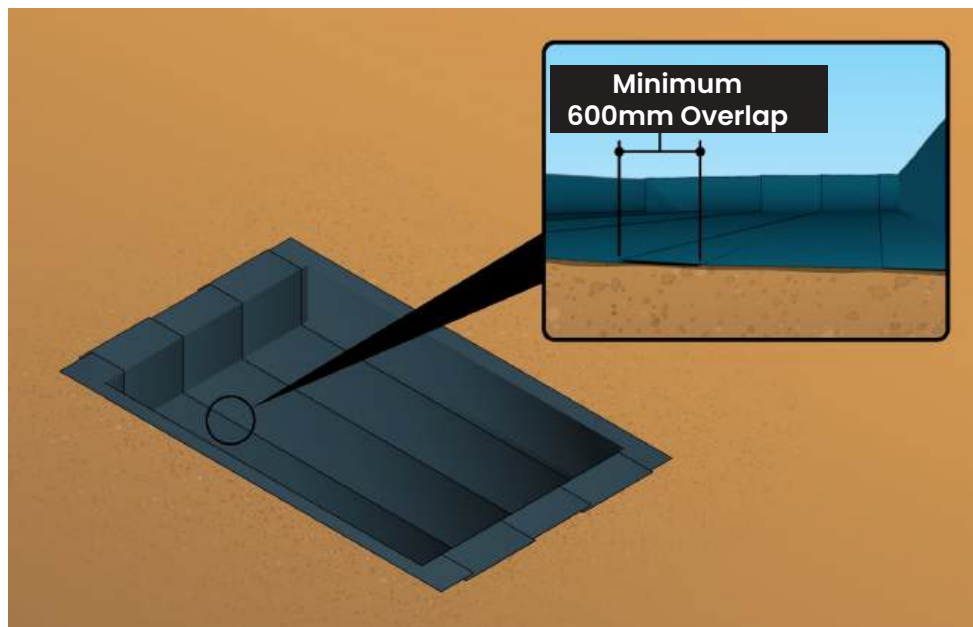

Figure 6 - Filter Fabric Installation

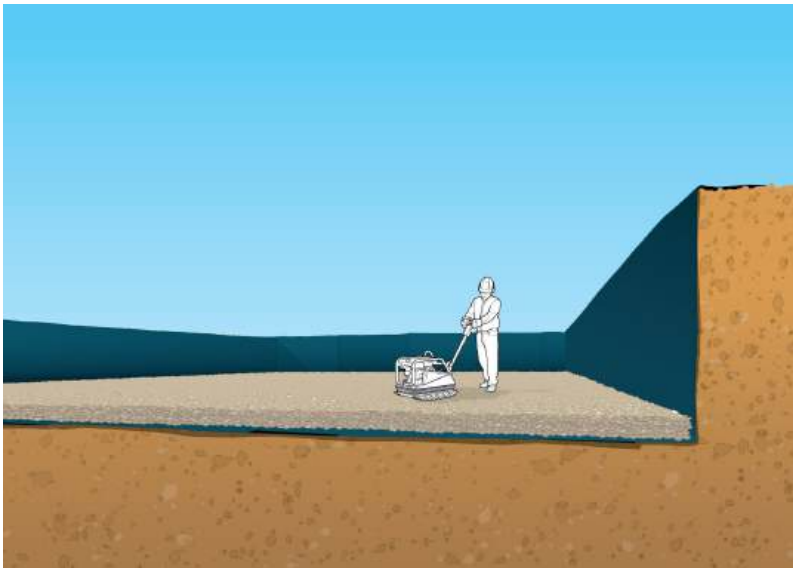

Figure 7 - Foundation Compaction with Plate Compactor

After the fabric has been laid out, place a level foundation of 3/4"-2" (19-51 mm) clean, crushed, angular stone over the entire excavated bottom. **The foundation thickness shall be a minimum of 6" (150 mm) for the NS1 and NS2 chamber.** Additional foundation stone thickness may be required, depending on the subgrade bearing capacity. Refer to the HydroStor Design Guide for more information. Using a vibratory roller, compact the stone foundation to achieve a flat level surface.

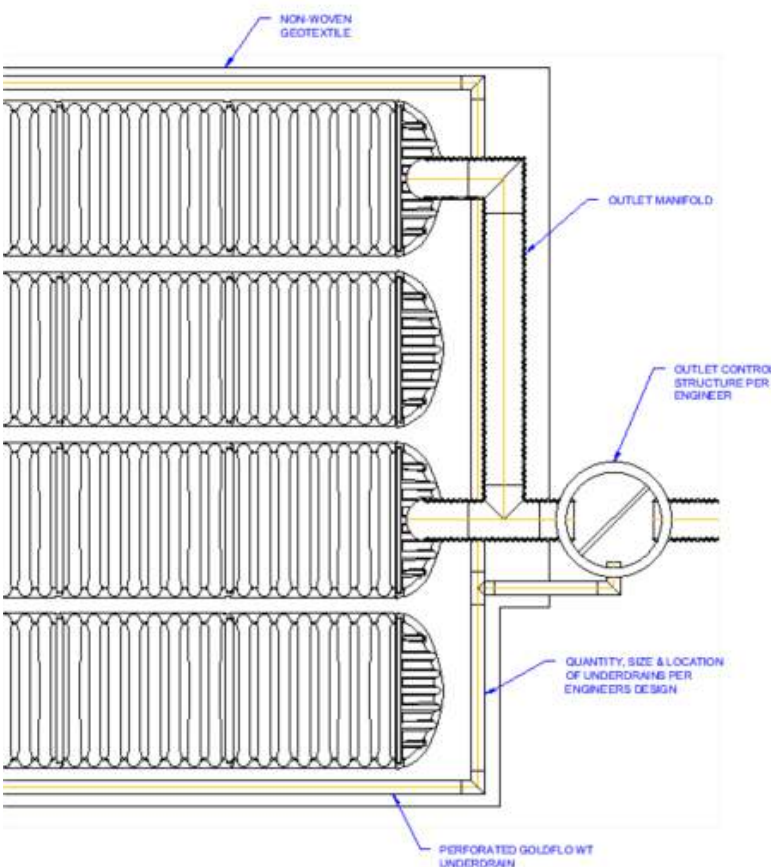

Figure 8 - Optional Underdrain

If specified on the project plans, the underdrain piping may be laid at this point. The underdrain is to be installed around the chamber system and should not be placed under a chamber footing. Refer to the Underdrain Detail Drawing for more information about underdrain installation.

Inlet Manifold Assembly and Chamber Placement

Upstream of the chamber system, an inlet structure should be installed. This structure will divert the water through a pre-treatment system, such as a Tricel Stormwater Quality Unit (TWQU) and/or a chamber sediment row.

A manifold is used to distribute the stormwater to the chamber rows. A manifold system will typically consist of Tricel GOLDFLO dual wall pipe and fittings. Pipe and fittings may be joined using split-band couplers. Lay out the manifold system using the project plans and appropriate details.

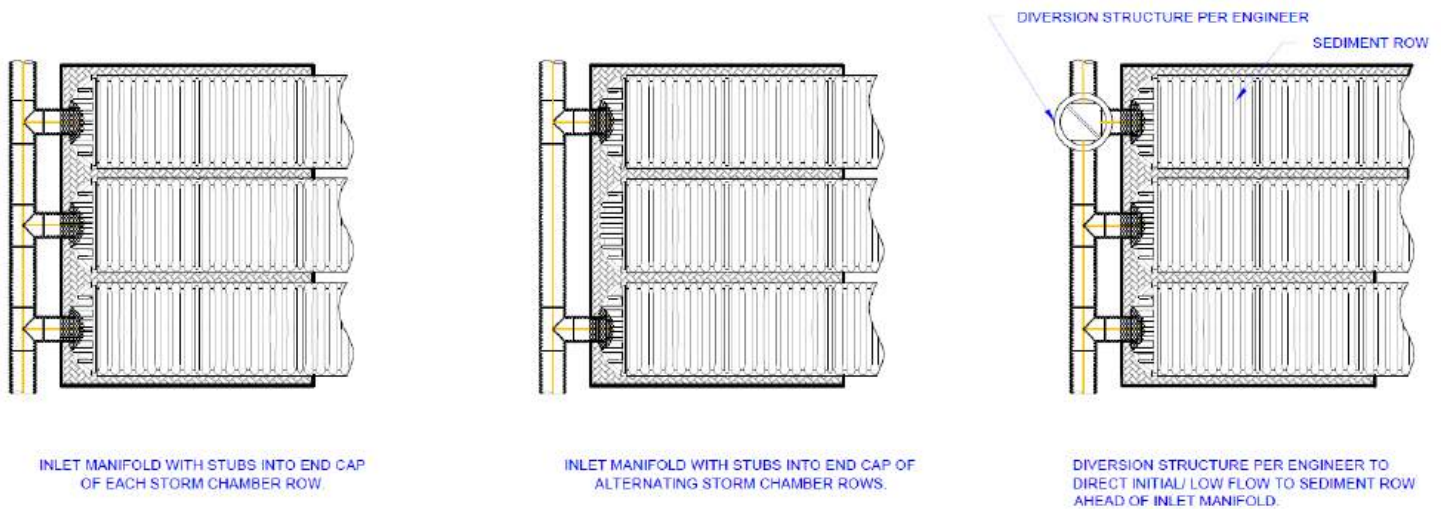

Figure 9 - Inlet Manifold Options

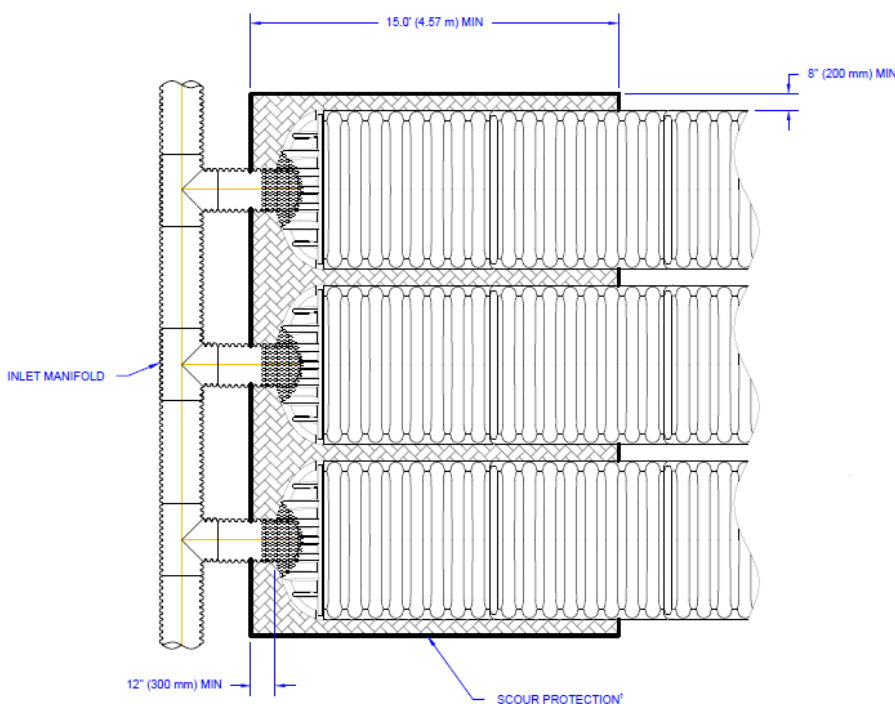

Figure 10 - Inlet Scour Protection

To alleviate the potential for scour at the inlet locations, lay a 15' (4.57 m) wide strip of an AASHTO M288 Class 1 woven stabilization geotextile, along the entire length of the manifold mainline, adequately covering the foundation stone beneath the inlet locations. The fabric should extend a minimum of 12" (300 mm) in front of the end caps and 8" (200 mm) on the sides of the chambers.

Position the end caps of each row with the inlet pipes. At the required locations/elevations, core an opening in the end cap the approximate outside diameter of the pipe and insert the inlet pipe. The inlet pipe should penetrate 300 mm into the end cap.

Repeat this process for each row. Cover any open void spaces greater than 19 mm on the end caps with a non-woven geotextile to prevent infiltration of the backfill material.

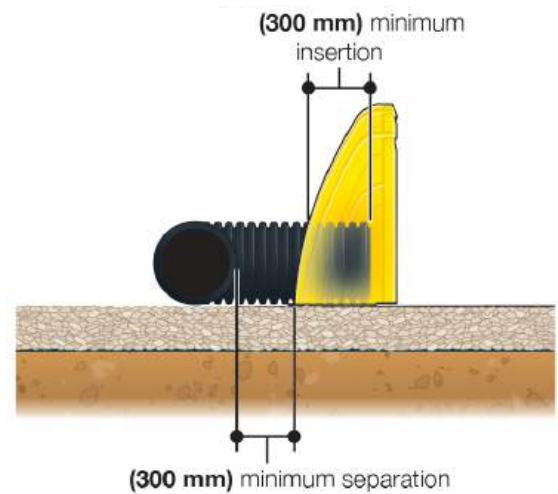

Figure 11 - Manifold / End Cap Connection

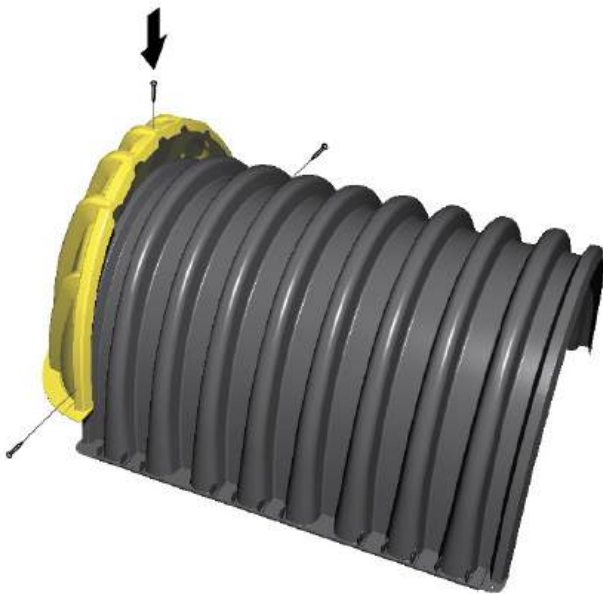

Figure 12 - End Cap Assembly

Position the chambers in line with the end caps. Note the orientation of the chambers. The chambers are stamped with arrows showing the direction for installation. The end caps will fit over the first rib of the chambers. The end caps should be fastened to the chambers with a minimum of 3 evenly spaced screws or fasteners to keep the end caps from shifting during the backfilling process.

The assembly of each row is achieved by overtopping the last rib of the initial chamber with the first rib of the succeeding chamber.

Each chamber is marked with the overlap locations as well as the installation direction. During the assembly process do not extend the chamber rows beyond the reach of the backfill placement equipment. End caps shall be used to terminate each row.

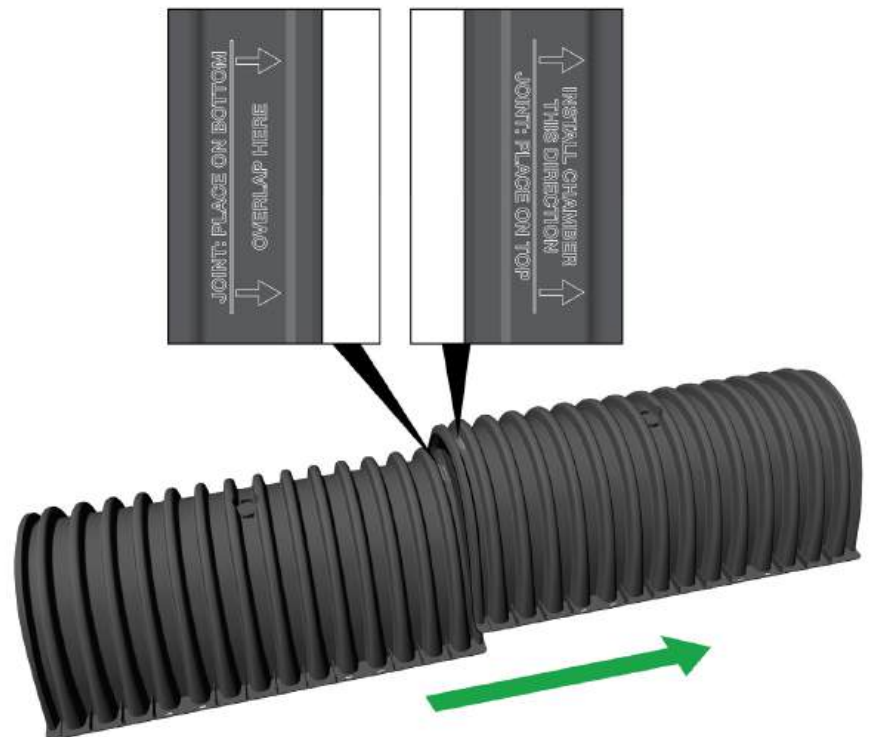

Figure 13 - Chamber Joint Assembly

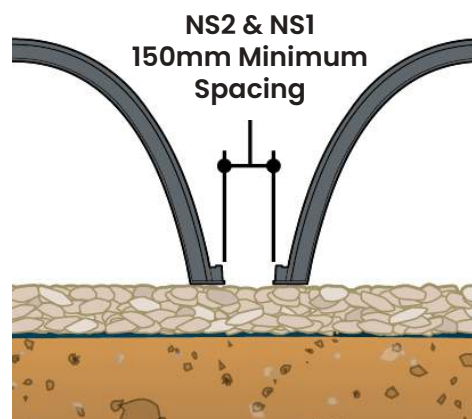

Figure 14 - Minimum Chamber Row Spacing

Maintaining a 150 mm minimum clear space for both the NS1 and NS2 between each row is required for adequate structural support. A brick, wooden block, or other spacer is recommended to maintain the required spacing between the chamber feet.

Chamber Outlet Options

The purpose of the outlet is to ensure that there are free-flowing conditions between the chambers and the outlet control structure. Multiple possible outlet configurations can be utilized. They include: An outlet manifold consisting of pipe stubs connected to the chamber end caps in the same fashion as the inlet manifold, a perimeter underdrain connected to the outlet control structure, or a combination of both.

The outlet control structure should be designed so that there is sufficient outflow from the chambers while allowing the chambers to reach full storage capacity. The outlet manifold sizing and configuration will vary based on the system sizing and requirements. Below is a typical outlet manifold configuration.

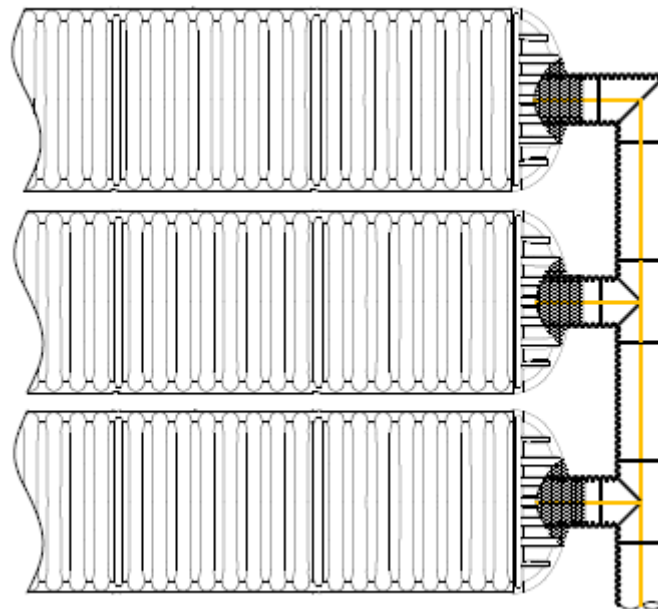

Figure 15 - Outlet Manifold Configuration

Pre-treatment / Sediment Row

Considering chambers have open bottoms, it is essential to utilise a pretreatment system to remove sediment and debris before the influent enters the chamber system. If the incoming effluent is untreated, the storage performance and service life of the system will be compromised. Tricel recommends pretreatment of the stormwater runoff by using either a water treatment device such as the Tricel Stormwater Quality Unit (TWQU) and/or a chamber sediment row. It is important to consider the local water quality regulatory requirements and the expected influent contamination.

Stormwater Quality Unit Option

- Pretreatment devices such as Tricel's TWQUs should be installed upstream of the chamber system to treat the initial stormwater runoff before it reaches the chamber system. Tricel offers several standard units and also has the ability to customise units to meet the job specific requirements. Refer to Tricel's TWQU Product & Bypass details for more information.

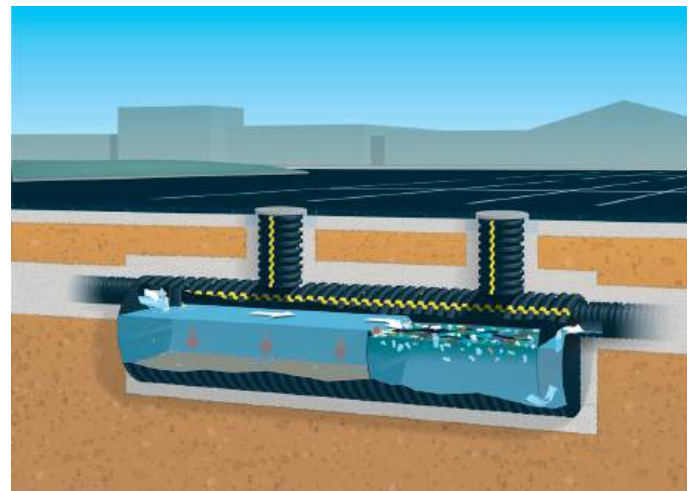

Figure 16 - Tricel Stormwater Quality Unit (TWQU)

Sediment Row Option

- The Sediment Row consists of a series of chambers installed directly on top of two layers of woven geotextile. The geotextile serves as a filter and prevents the sediment from clogging the foundation stone. The specified geotextile is also durable enough to withstand cleaning and maintenance procedures using water jet technology.
- The sediment row is designed with an access structure upstream of the inlet. The access structure should be installed prior to the placement of the chambers. The structure will be designed to divert the initial stormwater runoff to the sediment row. Flows that exceed the capacity of the sediment row will then be diverted to the system through the inlet manifold.
- Installation of the sediment row may begin after the foundation has been placed. For detailed layout dimensions, refer to the Engineer's layout or Tricel's standard Sediment Row detail.
- Two strips (minimum 1.27 m wide for the NS1 and 1.52 m wide for the NS2) of an approved AASHTO M288 Class 1 woven stabilization geotextile shall be placed over top of the foundation. The chamber row is then installed directly on top of the two layers of fabric. It is recommended that these two geotextile layers do not include any joints, overlaps or seams.
- A short stub of pipe can be used to connect the manhole to the end cap of the sediment row. It is recommended that a 300 mm diameter pipe for NS1 and a 600 mm diameter pipe for NS2 be used to allow access to the sediment row for maintenance procedures. Note that a pipe adapter is required to make these connections to the end caps of these systems.
- A non-woven geotextile is not needed over top of the chambers since the chamber side walls are not perforated.
- After placement of the adjacent chamber rows, backfilling may commence as described in this guide.



TRICEL
GENERATIONS OF INNOVATION

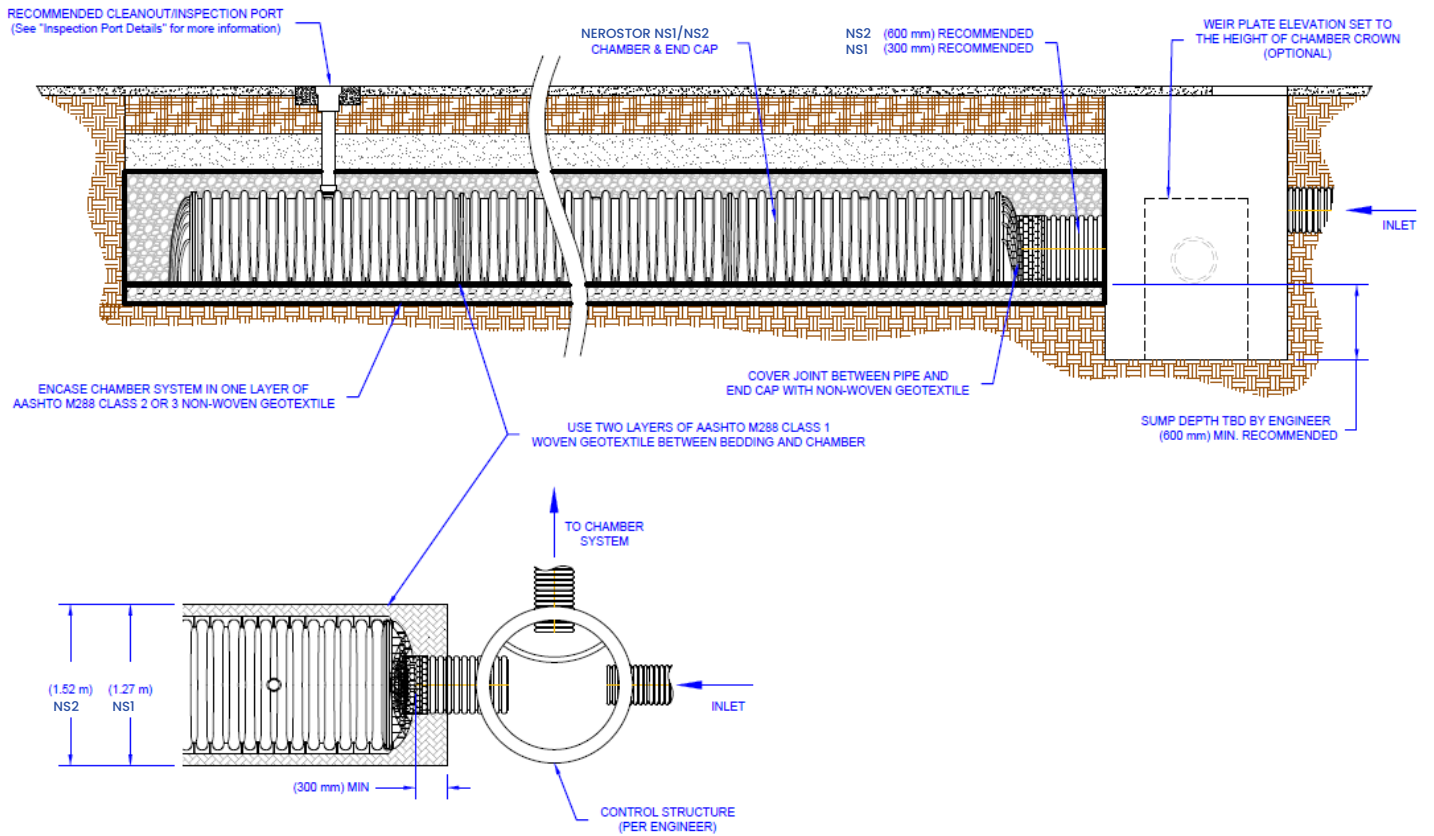

Figure 17 - Sediment Row

Vent / Inspection Port Placement

Inspection ports are not required for chamber systems; however, they may be installed to monitor the sediment and debris level within the system. Using the project plans, identify which chambers should be fitted with inspection ports.

The NS1 and NS2 chambers are equipped with a circular cut out point in the center of the chamber to accommodate a 100 mm diameter PVC inspection port.

Using a hole saw, cut out the opening at the appropriate location. A Fernco QuikSeal, Tap PVC, or approved engineering equivalent connection can be used to connect Schedule 40 or SDR 35 PVC pipe and fittings to build the inspection port as shown in Figure 18.

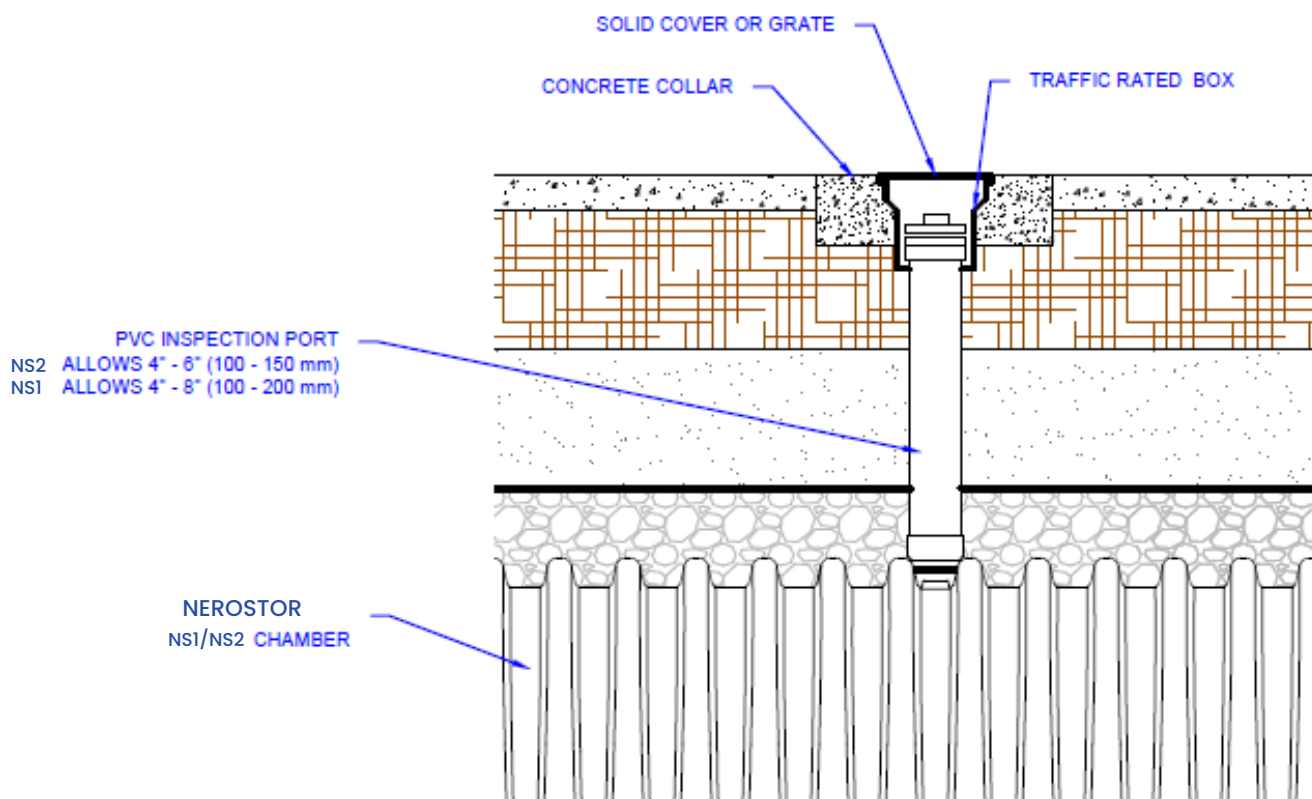

Figure 18 - Inspection Ports

Chamber Backfill Requirements

The backfilling process is critical to ensure long-term, trouble free operation of the chamber system. The backfill and chambers function together as a structural system to support the soil overburden and vehicular live loads. Therefore, proper backfill material selection and placement is critical. Refer to Table 2 for acceptable backfill material selection.

Table 2 - Acceptable Backfill Materials

Fill Material Location	Material Description	AASHTO M43 Designation
[D]* Final Backfill - Fill material for Layer D starts at the top of the C layer to the bottom of the pavement or to the finished grade of an unpaved surface. The pavement sub-base may be part of the final backfill.	Any backfill which provides adequate subgrade for the project per the engineer's plans. Plans shall indicate subgrade requirements.	N/A
[C]* Initial Backfill - Material for layer C starts at the top of the embedment zone (layer B) and continues to 18" (450 mm) above the top of the chamber for the NS1 and NS2. The pavement sub-base may be part of the initial backfill layer.	Well graded granular material, <35% fines.	AASHTO M45 A-1, A-2, A-3 or AASHTO M43 3, 357, 4, 467, 5, 56, 57, 6, 67, 68, 7, 78, 8, 89, 9, 10
[B]* Embedment Stone - Embedment stone will surround the chambers and extends from the top of the foundation stone (layer A) to the bottom of the fabric layer.	19 to 51 mm clean, crushed, angular stone.	AASHTO M43 3, 357, 4, 467, 5, 56, 57
[A]* Foundation Stone - Foundation Stone extends from the subgrade to the foot of the chambers.	19 to 51 mm clean, crushed, angular stone.	AASHTO M43 3, 357, 4, 467, 5, 56, 57

*Reference Figure 19

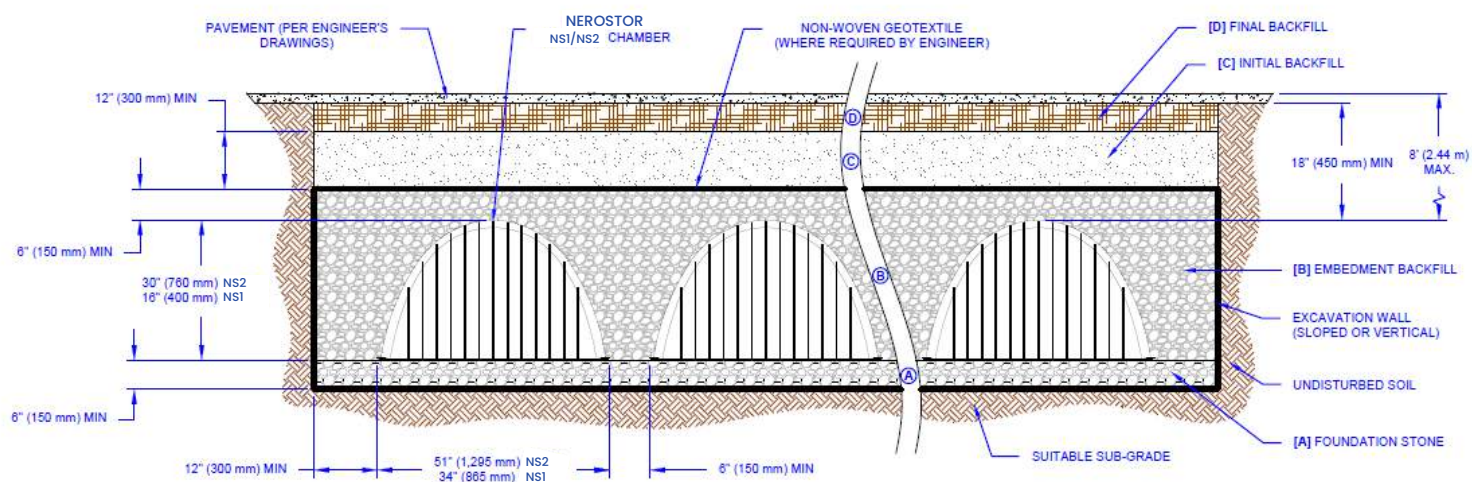

Figure 19 - Chamber Cross Section

Backfill material used for embedment, anchoring and for surrounding areas should comprise of a 19-51 mm, clean, crushed angular stone. Placement of backfill material for embedment and surrounding areas is best accomplished by using the long reach of an excavator or stone shooter/conveyor system. **No construction equipment shall be situated on top of the chamber system without the minimum embedment backfill placed over the chambers (150 mm for NS1 and NS2 chambers).** Compaction of the crushed stone around the chambers is not required, however, it is critical to ensure that the backfill is adequately knifed in around the manifolds and between the chamber corrugations.



Figure 20 - Backfill Placement with Excavator

In order to prevent chamber shifting and to maintain the appropriate row spacing (6" [150 mm] for NS1 and NS2), carefully deposit the stone evenly along the centerline of the chamber, allowing the stone depth between the rows to rise equally. During this phase, stone height between rows should not differ by more than 300 mm at any time.

After the anchoring phase is complete, stone placement may continue to surround the chambers and around the perimeter. The embedment backfill stone should fully encompass the chambers and should continue over the top the chamber crown to a minimum height of 150 mm for the NS1 and NS2 chambers. The backfill should also extend evenly from the chambers to the sidewalls of the excavation.



Figure 21 - Embedment Stone Placement

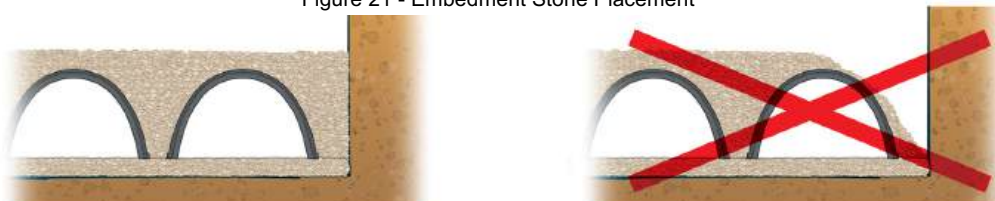

Figure 22 - Perimeter Backfill Placement

After the required embedment backfill thickness has been placed on top of the chambers (150 mm for NS1 and NS2), a small light weight tracked dozer (CAT® D4 or smaller) with ground pressure less than 4.5 psi (31 kPa) may be used to finalise the grading of cover stone. Stone must be pushed parallel to the chamber rows at all times.

Wheel and Roller Loads are Not Allowed.

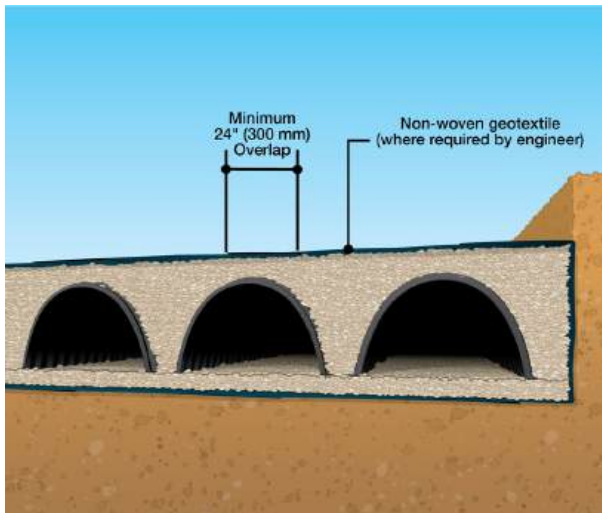

Figure 23 - Filter Fabric over Top of Chambers

After the embedment backfill has been evenly spread over the top of the chambers, the entire top of the stone bed should be covered with a layer of AASHTO M288 Class 2 or 3 non-woven fabric. All seams should be overlapped a minimum of 600 mm.

Utilising an excavator positioned next to the chamber rows, the initial backfill can now be placed over top of the fabric. After the minimum required initial backfill over top of the chambers has been placed (total cover of 450 mm for NS1 and NS2), compaction of the backfill may begin. It is

recommended that the compaction equipment travels parallel with chamber rows. Refer to Table 3 for Backfill Compaction Recommendations and to Table 4 for the maximum allowable construction loads.

Table 3 - Backfill Placement & Compaction Recommendations*

Fill Material Location	Placement Methods / Restrictions	NS1/NS2 Compaction Requirements
[D] Final Backfill	A variety of placement methods may be used. All construction loads must not exceed the limits in Table 4.	Subgrade will be placed and compacted to the requirements as shown on the site plans.
[C] Initial Backfill	Use of an excavator positioned off bed is recommended. Small excavators and small dozers may be allowed based on the information in Table 4.	Compaction will not begin until a minimum of 300 mm of material is placed over the chambers. Additional layers shall be compacted in 150 mm lifts to a minimum of 95% standard proctor density for well graded material. Roller gross vehicles are not to exceed 12,000 lbs. (5,443 kg) and dynamic force not to exceed 20,000 lbf (88.96 kN).
[B] Embedment Stone	No equipment is allowed on bare chambers. Use excavator or stone conveyor positioned off bed to evenly place the backfill around and on top of all of the chambers.	No compaction required
[A] Foundation Stone	Placement with a variety of equipment is acceptable to provide a stable, level base.	Placed in 6" (150 mm) lifts and compacted with a vibratory roller.

*Reference Figure 19

Minimum and Maximum Cover Heights

A minimum of 450 mm for the NS1 and NS2 chamber, measured from the top of the chambers to the bottom of pavement, is recommended for H-20 vehicle loading. If pavement is not to be used, the cover should be increased to a minimum of 600 mm of cover for NS1 and NS2 chambers for H-20 vehicular loading.

If the chambers will experience loading from construction equipment while the project is still being constructed, temporary fill may be placed over the system during construction and removed after the heavy construction equipment traffic is rerouted. Refer to Table 4 for maximum allowable construction vehicle loads at various backfill depths.

The maximum burial depth for NS1 & NS2 chambers is 2.44 m. The cover height is measured from the top of the chambers to the top of the pavement or final backfill layer if pavement is not present.

Table 4 - Maximum Allowable Construction Vehicle Loads*

Material Location	Fill Depth above chambers (in.)	Max Allowable Wheels Loads		Max Allowable Track Loads		Max Allowable Roller Loads
		Max Axle Load for Trucks lbf (kN)	Max Wheel Load for Loaders lbf (kN)	Track Width in (mm)	Max Ground Pressure psf (kPa)	Max Drum Weight Dynamic Force lbf (kN)
[D] FINAL FILL MATERIAL	36" (900) COMPACTED	32,000 (142)	16,000 (71)	12" (300)	3,420 (163.75)	38,000 (169)
				18" (450)	2,350 (112.52)	
				24" (600)	1,850 (88.58)	
				30" (750)	1,510 (72.30)	
				36" (900)	1,310 (62.72)	
[C] INITIAL FILL	24" (600) COMPACTED	32,000 (142)	16,000 (71)	12" (300)	2,480 (118.74)	20,000 (89)
				18" (450)	1,770 (84.75)	
				24" (600)	1,430 (68.47)	
				30" (750)	1,210 (57.94)	
				36" (900)	1,070 (51.23)	
	24" (600) DUMPED	24,000 (107)	12,000 (53)	12" (300)	2,245 (107.49)	NS1/NS2: 20,000 (89) Gross weight of roller not to exceed 12,000lbs (5,443 kg)
				18" (450)	1,625 (77.81)	
				24" (600)	1,325 (63.44)	
				30" (750)	1,135 (54.34)	
	18" (450)	24,000 (107)	12,000 (53)	12" (300)	2,010 (96.24)	NS1/NS2: 20,000 (89) Gross weight of roller not to exceed 12,000lbs (5,443 kg)
				18" (450)	1,480 (70.86)	
				24" (600)	1,220 (58.41)	
30" (750)				1,060 (50.75)		
[B] EMBEDMENT ZONE	12" (300)	NOT ALLOWED	NOT ALLOWED	12" (300)	NS1/NS2: 1,540 (73.74)	NOT ALLOWED
				18" (450)	NS1/NS2: 1,190 (56.98)	
				24" (600)	NS1/NS2: 1,010 (48.36)	
				30" (750)	NS1/NS2: 910 (43.57)	
	6" (150)	NOT ALLOWED	NOT ALLOWED	12" (300)	NS1/NS2: 1,070 (51.23)	NOT ALLOWED
				18" (450)	NS1/NS2: 900 (43.09)	
				24" (600)	NS1/NS2: 800 (38.30)	
				30" (750)	NS1/NS2: 760 (36.39)	

*Reference Figure 19



TRICEL

GENERATIONS OF INNOVATION

When it comes to stormwater chambers, the road from good to great leads directly to NeroStor, the industry's highest performing chambers. They meet or exceed proven ASTM structural, design and product standards, while including features that matter to the designer and installer.

NS1		NS2	
6" (150 mm) minimum	foundation	6" (150 mm) minimum	
6" (150 mm)	chamber spacing	6" (150 mm)	
34" (864 mm)	chamber width	51" (1,295 mm)	
12" (300 mm)	backfill at edge of system	12" (300 mm)	
16" (406 mm)	chamber height	29.7" (754 mm)	
18" (450 mm)	minimum cover	18" (450 mm)	
8' (2.44 m)	maximum burial depth	8' (2.44 m)	

Available Sizes



NS1

31 ft ³ (.88 m ³ /chamber)	Installed Storage Capacity*	75 ft ³ (2.12 m ³ /chamber)
16" (406 mm)	Height	29.7" (754 mm)
34" (864 mm)	Width	51" (1,295 mm)
87.8" (2,253 mm)	Length	87.1" (2,212 mm)
Lightweight Option	Special Features	Integrated Handles
Meets or Exceeds	ASTM Standards	Meets or Exceeds



NS2

The NeroStor NS1 stores 4.3 ft³ of stormwater per linear foot (.12 m³ per linear meter) or 31ft³ (.88 m³) per chamber, and is for projects with limited burial depths

The NeroStor NS2 stores 10.6 ft³ of stormwater per linear foot (.3 m³ per linear meter) or 75 ft³ (2.12 m³) per chamber, and is designed for projects with limited burial depths.

Tricels NeroStor chambers meet rigorous ASTM standards and include value-added design features that take this new chamber option from good to great.

Performance

- High performance polypropylene material
- Meets or exceeds **ASTM F2418** product standard & **ASTM F2787** design standard
- Meets **AASHTO H20** live load & **HL93** design load requirements
- Advanced injection molding technology for maximum structural performance



For more information or to receive a quote, contact your Tricel's representative.