



TRICEL

GENERATIONS OF INNOVATION

Tricel Tero 1-50

Installation & homeowner Manual

Packaged Filter System

Engineering a green future



Contents

Contents	2
1 Health & Safety precautions.....	4
1.1 General	4
1.2 Electrical/maintenance	5
1.3 Installation:	5
INSTALLATION MANUAL	6
2 Installation	6
2.1 Inspection on receipt of Tricel TERO modules	6
2.2 Positioning and precautions	6
2.3 Tricel TERO Systems: Single Zone	7
2.3.1 TERO module installation – step by step guide	7
2.4 Tricel TERO Systems: Multiple Zones	8
2.4.1 Indexing valve	8
2.4.2 Indexing valve – step by step installation procedure	8
3 Commissioning	10
3.1.1 TERO Module Treatment	10
HOMEOWNER MANUAL	11
4 Introduction: Tricel TERO.....	11
4.1 How a Tricel TERO Plant works:	12
4.2 Tricel Puraflo: Typical Layout	13
4.2.1 Plan view of Typical Tricel Puraflo Tertiary System	13
4.3 Tricel TERO Applications.....	13
4.3.1 Tertiary Treatment.....	13
5 Tricel TERO Range.....	15
5.1 System Specifications	15
5.1.1 TERO Module Treatment.....	15
5.2 System Components	15
5.2.1 Tricel TERO Module.....	15
5.2.2 Pipework.....	16
5.3 System Layout Drawings:.....	16
5.3.1 Tricel TERO 2 Module System	16
5.3.2 Tricel TERO 3 Module System.....	16
6 Transportation & Lifting	17
7 Installation	17
8 Commissioning	17

9	Disposal of Treated Water	17
10	Maintenance.....	18
10.1	Annual Service (Available from your supplier)	18
10.2	Regular Maintenance of Relating systems	19
10.2.1	Waste Water Treatment Plant.....	19
10.2.2	Pump Chamber (If applicable)	19
10.2.3	Control Panel	19
10.3	De-sludging.....	19
11	Operating Conditions.....	20
11.1	Conditions:.....	20
12	Troubleshooting	22
12.1	Plant Operation.....	22
12.2	Odours	23
13	Certification	24
13.1	Tricel TERO	24

1 Health & Safety precautions

This manual contains basic information on the installation, operation and maintenance of the Tricel TERO wastewater treatment system. For this reason, it is essential that these instructions are carefully read and understood before installation or commissioning by both the installation crew as well as those responsible for the operation and maintenance of the system.

This manual should be readily available at the location of the system. It is the responsibility of the homeowner to ensure that the wastewater treatment system is operated and maintained correctly and in a safe manner at all times. As safety and security are of vital importance, the following aspects are critical:

1.1 General

- Ensure that all the information contained in this manual is adhered to at all times.
- Treated wastewater is not suitable for human consumption. It is unhealthy for humans, pets, and wildlife to drink or come in contact with surface or ground water contaminated with sewage.
- It is important that the lid is tightly secured to prevent accidental access.
- Never enter a tank, unless qualified to do so.
- Naked flames shall not be used in the vicinity of the tank due to the danger of combustion.
- Sewage and sewage effluent can carry micro-organisms and gases harmful to human health.
- Any person carrying out work on the wastewater treatment system must be appropriately trained.
- Suitable protective clothing; including waterproof/abrasion-resistant gloves, overalls, safety footwear, eye, ear and respiratory protection, goggles (face visors are particularly effective against splashes) should be worn at all times. All protective clothing must be in good condition and be fit for its intended purpose.
- Always remove contaminated clothing and protective equipment after working with wastewater treatment plants. Wash hands and face prior to eating, drinking or smoking.
- Wastewater treatment plants contain very low levels of oxygen. Hydrogen sulphide, methane, carbon dioxide and other life-threatening gases are also present. Tanks have manholes covers to provide access to the tank only in times of cleaning and inspecting the tank from outside. The manhole covers must always be in place and secure.
- Keep vehicles and other heavy equipment away from the wastewater treatment plant and percolation area.
- Erect a safety barrier around open manholes to prevent anyone from accidentally falling down the manholes.
- Keep children away from the septic system when it is being worked on.
- Do not smoke near wastewater treatment plants. Combustible gases could be present and cause an explosion.
- Contact a plumber or other qualified person if you smell 'sewer gases'. They can identify the source and correct it immediately.
- The sewage treatment process uses many beneficial microorganisms, like bacteria, in the treatment process. However, the plant also contains harmful bacteria, viruses and disease-organisms. Liquid and solid contents of the septic system are capable of causing infectious diseases.

1.2 Electrical/maintenance

- Never use electrical lights, appliances or power tools in or close to water or wet ground near the wastewater treatment plant or percolation area. This can result in electrical shock or explosion.
- When working with machinery/electrical equipment, proximity of water shall be noted. Electrical equipment shall not be wet when working with it.
- There is potential danger when de-sludging and therefore this shall never be done alone.
- A wastewater treatment system that fails to fully treat sewage due to poor maintenance or overloading may allow excess nutrients (phosphorus and nitrogen) to reach nearby lakes and streams, promoting algae and plant growth. Algal blooms and abundant weeds may make lakes unpleasant for swimming, boating, and other water-based activities. This plant growth can also affect water quality for fish and wildlife habitat. As plants die and settle to the bottom, they are broken down by bacteria that use up oxygen that fish need to survive.
- It is the responsibility of the owner to ensure that the wastewater treatment plant is operated and maintained correctly at all times.
- It is advised that the owner enters into a yearly Service Agreement to ensure the correct operation of their wastewater treatment plant.

1.3 Installation:

- Excavation work should be planned with due regard to health and safety requirements.
- Excavated material should either be shored or battered back to a “safe” angle.
- Use appropriate lifting equipment.
- Care should be taken around grounds work machinery.
- Keep proper footing and balance at all time.

INSTALLATION MANUAL

NOTE: This section of the Tricel TERO Manual is for the installer. For Home Owner information on the Tricel TERO, go to page 11.

2 Installation

Important

Prior to the installation of the Tricel TERO system, it is important to carefully read these installation instructions.

2.1 Inspection on receipt of Tricel TERO modules

- Tricel TERO modules should be visually inspected for damage which may have occurred during transport prior to installation. Any damage should be notified to the delivery driver and/or to your supplier. Do not attempt to carry out any unauthorised repairs, as this will invalidate the warranty on the modules.
- Once the modules have been installed, we cannot accept any claims for damage.

2.2 Positioning and precautions

- Only suitably qualified personnel should perform the installation of the Tricel TERO system.
- The groundwater level on the site must never rise above the base of the Tricel TERO modules.
- Suitably sized equipment will be required to excavate the hole and to lift the Tricel TERO system into place (minimum: 6-ton machine).
- The Tricel TERO system should not be installed in an area subject to flooding or excessive water runoff as no flood waters should enter the tank.
- When selecting the location of the Tricel TERO system, ensure that it is always accessible for future maintenance.
- The Tricel TERO system, if installed in the ground, should be installed at a depth greater than 800mm. The System Lid needs to be full accessible at all times for future maintenance.
- The location for each element of the system must be known and marked out prior to installation.
- The gravel base discharge area must be installed before the Tricel TERO system is installed. **Tricel is not responsible for the design and installation of the discharge area.**

2.3 Tricel TERO Systems: Single Zone

2.3.1 TERO module installation – step by step guide

Step	Description
Site Preparation	1 The location for each element of the system must be known and marked out.
	2 Prepare excavation as per manufacturer's guidelines.
	3 As required, install a Waste Water Treatment Plant as per the manufacturer's guidelines.
	4 Note: A pump is required with the use of the TERO Tertiary treatment module. If WWTP does not contain a pump, install a separate pump chamber in accordance with manufacturer's guidelines.
TERO Module Installation	5 Level the ground and prepare a bed of 12-32mm pea gravel for the base for the installation of the TERO module, taking note of the water table and site conditions. NOTE: The TERO module must always be installed above the water table, and the lid must <u>NOT</u> be covered. Dig and back fill the base with gravel, as required to ensure the module complies with these requirements. The size of the area covered by the gravel base is determined by the Percolation Values (PVs) obtained from the following table: Table 10.1: EPA Codes of Practice
	6 A trench, for the rising main, must be dug from the pump chamber/water treatment plant to the TERO module inlet assembly. Width and depth of the trench is to be determined based on installation depth and location of the TERO module. The rising main must be surrounded by 150mm of gravel all around. Backfill the rest of the trench with existing soil.
	7 Using the floor design of the tank as a guide, install two lifting ropes around the module, ensuring they sit flat . Lift the TERO module and position centrally on the gravel base.
	8 Using the Philmac connection on the inlet assembly, connect the inlet pipework to the WwTP/pump chamber as required. NOTE: The inlet assembly should be connected to the WwTP/pump chamber in single zone systems. An indexing valve is required in multi-zone systems.
	9 Once the TERO module has been connected to the Wastewater Treatment system, backfilling around the module can be completed. NOTE: Maximum backfill height of 800mm permitted. NOTE: The Tricel TERO module must not be covered with soil.

2.4 Tricel TERO Systems: Multiple Zones

- Tricel TERO systems with Four or more modules will consist of multiple zones. Each zone will consist of two or three modules.
- Wastewater is pumped to each zone intermittently via an indexing valve, which is positioned between the pump chamber and the TERO modules.

2.4.1 Indexing valve





- The indexing valve supplied to effectively pump each zone in the Tricel TERO system is a 4-outlet indexing valve: Used in systems of 2 - 4 zones.

Important

For drawings of Multiple Zone Tricel TERO systems, please visit <http://ie.tricel.eu/downloads/>

2.4.2 Indexing valve – step by step installation procedure

Step	Description	
1	Apply PTFE tape to threads of Philmac fitting and thread into inlet of indexing valve.	
2	<p>Assemble each of the active outlets required as shown below:</p> <ol style="list-style-type: none"> 1. Indexing valve 2. Threaded pipe (supplied with valve) 3. Union nut 4. Union end 5. 50mm length of 32mm pipe 6. 40-32mm reducing bush 7. 40mm elbow <p>Note: The elbow (object 7. above) can be orientated to suit the installation.</p>	

3	<p>Push hose tails into the flexible outlet pipework and secure with hose clips.</p>	
4	<p>Using a 50mm hole saw, drill the inlet hole and the required number of outlet holes. The inlet hole/outlet holes can be positioned at alternative locations around the bottom of the distribution box to suit the site conditions.</p>	
5	<p>Place the indexing valve into the distribution box, connect the outlet pipes (to TERO modules) and inlet pipe (from the pump chamber) to the indexing valve.</p>	
6	<p>Secure distribution box riser in place using six 25mm pan screws.</p>	
7	<p>Position the indexing valve as close to the TERO modules as site conditions allow.</p>	

3 Commissioning

Important

The commissioning of a Tricel TERO system must only be done by a Tricel- approved service technician.

- It is important that Tricel commission the Tricel TERO system to verify that the system has been installed correctly and ensure that the Tricel TERO will achieve the required treatment levels.
- The commissioning of the Tricel TERO system is done as part of the installation, when installed by Tricel.

3.1.1 TERO Module Treatment

Tricel TERO Modules		1	2	3	4	5	6	7	8	9
Max. Population Equivalent	PE	6	12	18	24	30	36	42	48	54
No. of Zones	-	1	1	1	2	2	2	3	4	3
Design Flow Rate (max)	L/day	900	1800	2700	3600	4500	5400	6300	7200	8100
BOD Load (max)	Kg/day	0.135	0.27	0.405	0.54	0.675	0.81	0.945	1.08	1.215
Overall Length	m	2.44	2.44	2.44	4.88	4.88	4.88	4.88	4.88	4.88
Overall Width	m	1.22	2.44	3.66	2.44	3.66	3.66	4.88	4.88	6.1
Overall Height	m	1.07	1.07	1.07	1.07	1.07	1.07	1.07	1.07	1.07
Weight *	Kg	515	1,031	1,546	2,062	2,577	3,093	3,608	4,124	4,639

*Weight may vary due to moisture content in Coconut Fibre

HOMEOWNER MANUAL

NOTE: This section of the Tricel TERO Manual is for the Home Owner. For Installer information on the Tricel TERO, go to page 5.

4 Introduction: Tricel TERO

Tricel TERO is a modular wastewater tertiary treatment system which can cater for large or small populations. It is a flexible system which can treat effluent from one-off domestic houses, to small communities and light commercial applications through the implementation of additional TERO modules.

The Tricel TERO system uses Coconut fibre to break down the effluent making this type of treatment system popular, using little to no energy. The Tricel TERO system works in conjunction with your wastewater treatment plant. The wastewater is distributed evenly over the top of the Coconut fibre, using a specially designed pipe network, to ensure optimum performance. Through a combination of biological, chemical and physical processes the Coconut fibre treats the wastewater as it filters through. The Tricel TERO is designed such that maintenance requirements are minimised while at the same time effectively treating effluent.

The Tricel TERO is a tertiary treatment as part of a complete Wastewater Treatment system.

4.1 How a Tricel TERO Plant works:

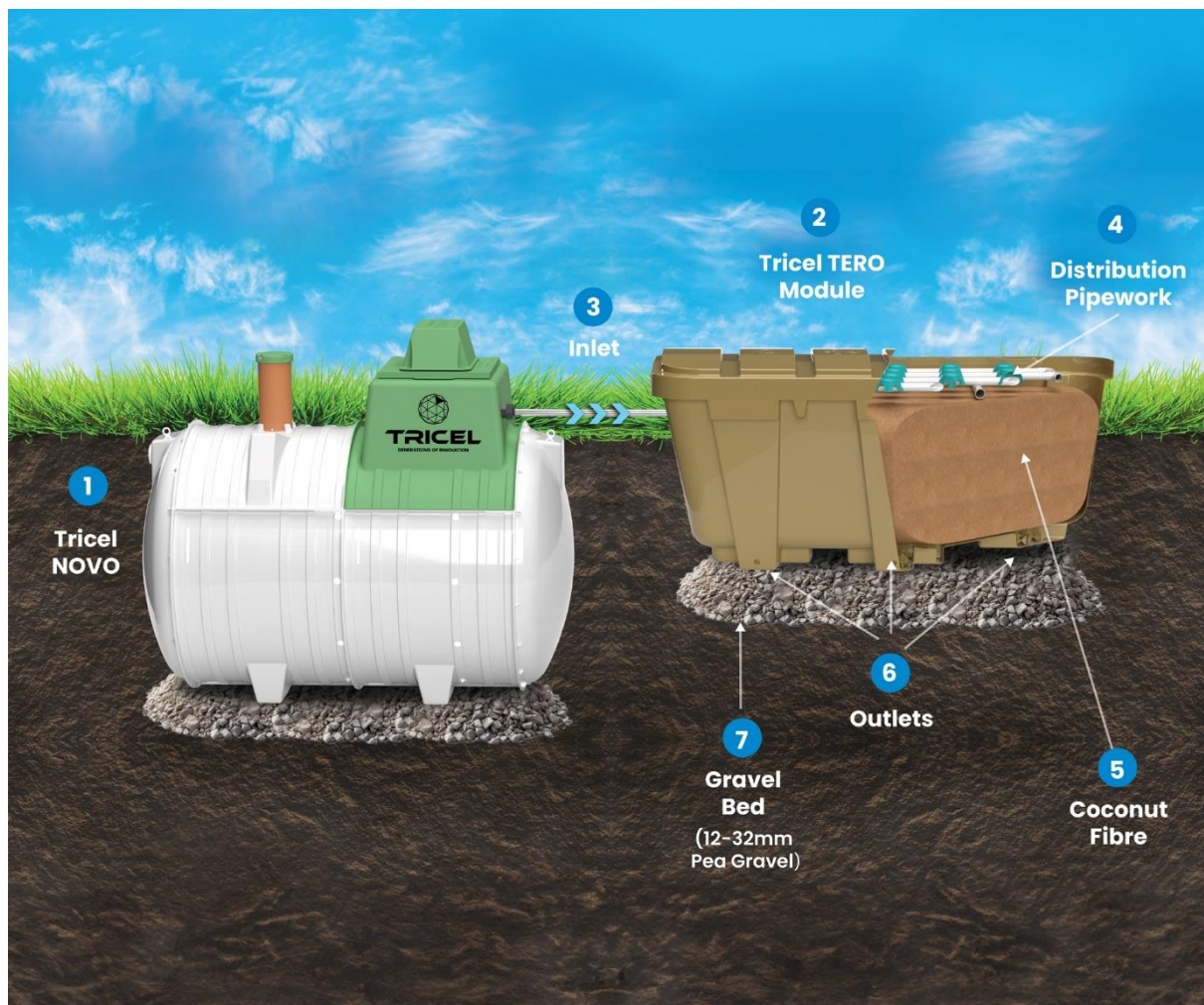

Typical Tricel TERO System

Stage 1

Liquid effluent is pumped, by a submersible pump, intermittently on-demand to the TERO module.

Stage 2

Effluent is distributed evenly onto the Coconut fibre via a distribution grid at the top of each TERO module.

Stage 3

Liquid effluent undergoes treatment as it filters through the Coconut fibre in the TERO modules.

Stage 5

Treated wastewater flows from the outlet and is discharged to a percolation area/polishing filter.

4.2 Tricel Puraflo: Typical Layout

4.2.1 Plan view of Typical Tricel Puraflo Tertiary System

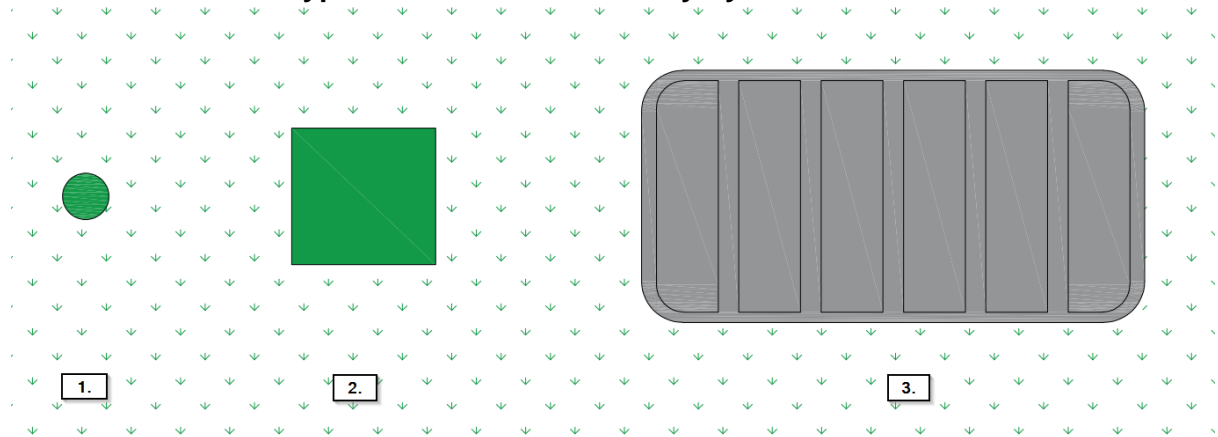

1. Desludge Cover – Access to primary chamber for desludging
2. Manhole Cover – Outlet from waste water treatment plant*
3. Tricel TERO Module – Number of modules depend on loadings

*Some Wastewater Treatment systems may only have one manhole cover.

4.3 Tricel TERO Applications

Tricel TERO modules are used as tertiary treatment applications within the Wastewater Treatment system.

4.3.1 Tertiary Treatment

- Environmentally sensitive sites or sites that are restricted in terms of space, often require a higher level of treatment. This is achieved by passing the secondary treated wastewater through the Tricel TERO modules, within which the wastewater is treated to a higher treatment level this is known as tertiary treatment. Tertiary treatment will achieve very high-level pathogen and nutrient reduction.

Tricel Tero Tertiary Treatment System (Complete Tricel Treatment System)

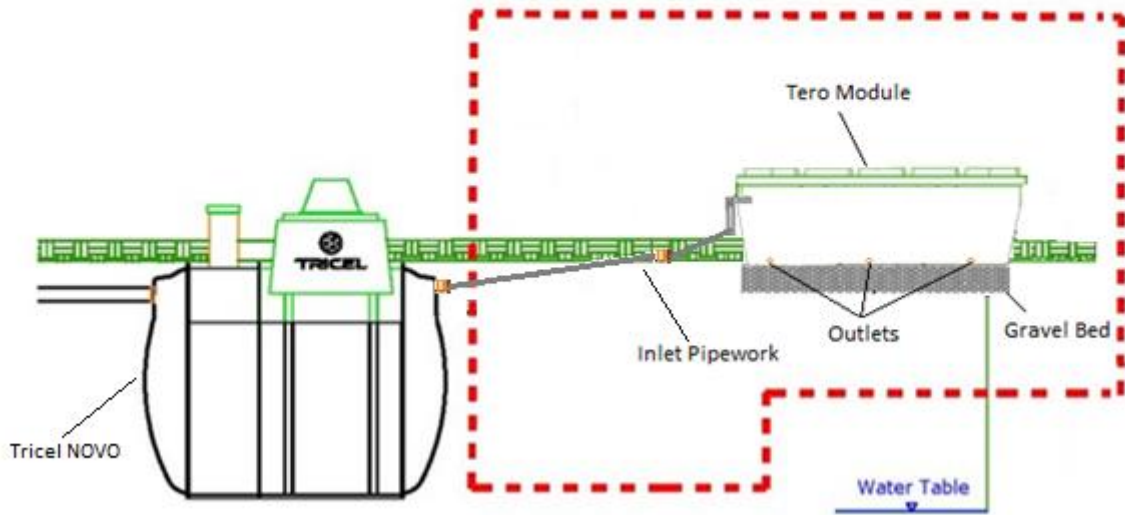

Tricel Tero Tertiary Treatment System (Third Party WWTP and Pump Chamber)

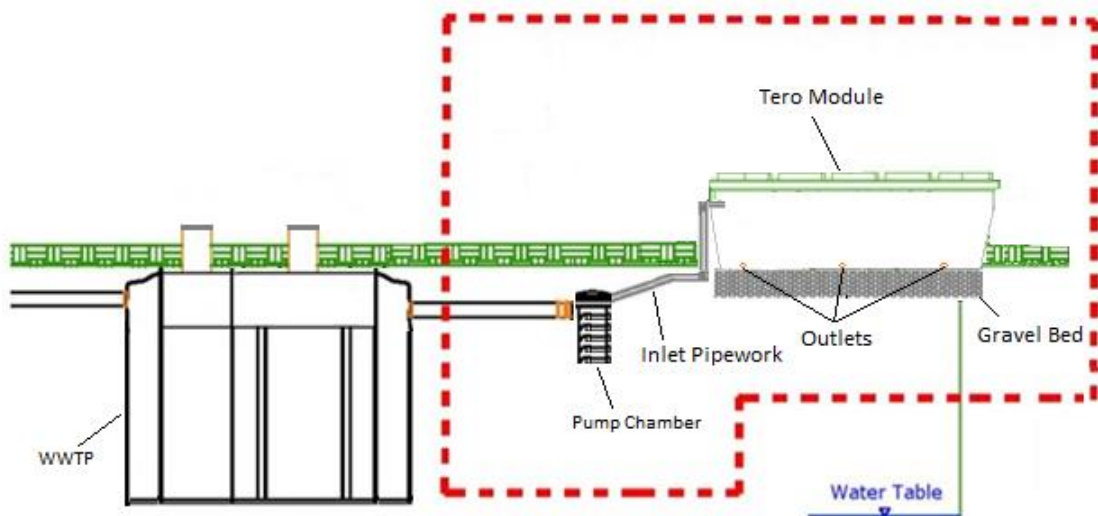

5 Tricel TERO Range

5.1 System Specifications

Tricel TERO is a flexible system for treating wastewater. Tricel TERO systems are implemented in zones and each zone contains multiple modules, as outlined in the table below. In systems comprising of multiple zones, the wastewater is pumped to each zone sequentially ensuring equal dispersion and optimum treatment.

5.1.1 TERO Module Treatment

Tricel TERO Modules		1	2	3	4	5	6	7	8	9
Max. Population Equivalent	PE	6	12	18	24	30	36	42	48	54
No. of Zones		1	1	1	2	2	2	3	4	3
Design Flow Rate (max)	L/day	900	1800	2700	3600	4500	5400	6300	7200	8100
BOD Load (max)	Kg/day	0.135	0.27	0.405	0.54	0.675	0.81	0.945	1.08	1.215
Overall Length	m	2.44	2.44	2.44	4.88	4.88	4.88	4.88	4.88	4.88
Overall Width	m	1.22	2.44	3.66	2.44	3.66	3.66	4.88	4.88	6.1
Overall Height	m	1.07	1.07	1.07	1.07	1.07	1.07	1.07	1.07	1.07
Weight *	Kg	515	1,031	1,546	2,062	2,577	3,093	3,608	4,124	4,639

*Weight may vary due to moisture content in Coconut Fibre

5.2 System Components

5.2.1 Tricel TERO Module

Dimension	Unit	Value
A	mm	1078
B	mm	1012
C	mm	2232
D	mm	1224
E	mm	2444
Height of Coconut fibre in Module	mm	780
Vol. of Coconut fibre in Module	M ³	1.75

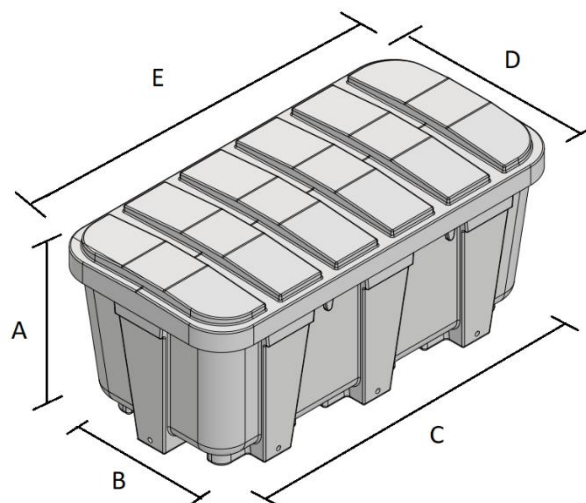

Warning

It is imperative that the treatment system is not overloaded hydraulically or organically. The number of modules that are required to treat the wastewater has been designed in accordance with the EPA CoP. If the owner feels that the modules are being overloaded, please contact Tricel, as it is possible to add modules to accommodate any extra loadings.

5.2.2 Pipework

The pipework supplied with the Tricel TERO modules used for the dispersion of wastewater on top of the Coconut fibre inside the TERO modules, is in accordance with BS 3505: 1986*

*Specification for unplasticized polyvinyl chloride (PVC-U) pressure pipes for cold potable water.

5.3 System Layout Drawings:

5.3.1 Tricel TERO 2 Module System

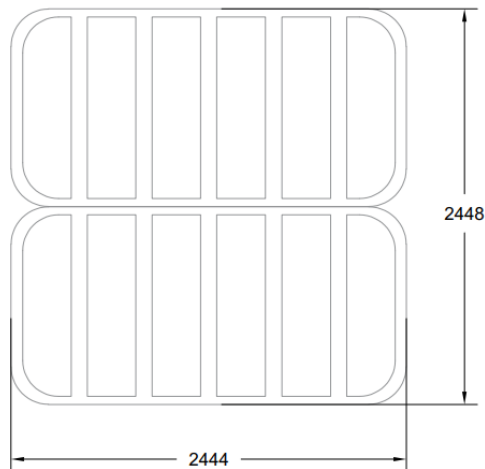

5.3.2 Tricel TERO 3 Module System

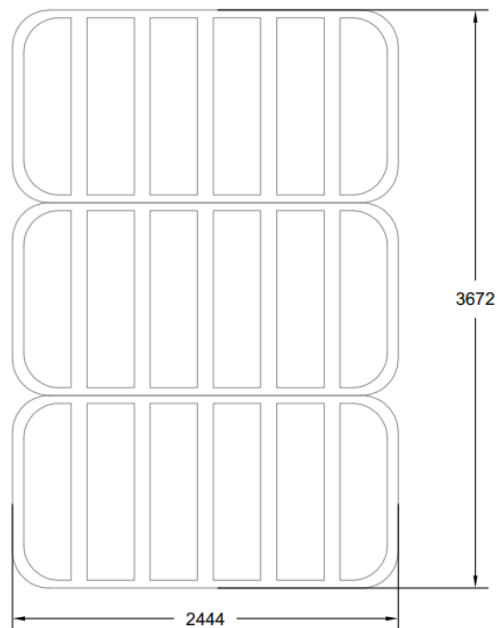

Important

If you require drawings for larger Tricel TERO systems, please visit <http://ie.tricel.eu/downloads/>

6 Transportation & Lifting

- Tanks must be held down during transportation using nylon straps, do not use cables or chains to secure the modules.
- Do not over tighten straps that can result in deformation of the module shell.
- Do not drop or roll modules from the truck.
- Move modules only by lifting and setting, do not drag or roll.
- Always set the module(s) on flat, smooth ground clear of debris etc.
- Modules are best lifted by a machine and webbing lifting straps – do not use chains or wire ropes in contact with the modules.
- Care is needed to control the lift to ensure the modules are not damaged.
- Always lift modules using the design of the floor as a guide for securing straps.

7 Installation

IMPORTANT

The installation of a Tricel TERO system must only be carried out by a Tricel authorised distributor or a Tricel service technician.

8 Commissioning

IMPORTANT

The Commissioning of a Tricel TERO system must only be carried out by a Tricel authorised distributor or a Tricel service technician.

9 Disposal of Treated Water

The treated wastewater from the Tricel TERO system should be disposed of as per guidelines from the planning regulations issued by your local authority.

10 Maintenance

Warning

When working on the Tricel TERO system during routine maintenance & servicing, please follow all national health and safety regulations. Sewage and sewage effluent can carry micro-organisms and gases harmful to human health. Any person carrying out maintenance on the system must be appropriately trained. Suitable protection equipment including gloves, goggles etc., should be worn at all times. Always remove contaminated clothing and protective equipment after completion of work. Wash hands and face prior to eating, drinking or smoking.

The Tricel TERO system is designed with the best of quality and performance in mind to meet your specific wastewater treatment requirements and to provide years of trouble-free use. However, a certain amount of system maintenance is required on an on-going basis to ensure that the system is working correctly.

This is the responsibility of the homeowner.

Failure to maintain your system could also result in reduced effectiveness and increased maintenance and/or replacement costs in the long-term.

10.1 Annual Service (Available from your supplier)

- The Tricel TERO system will require a full service (available from your supplier) once a year to guarantee the efficiency of the system is maintained. Service personnel must be accommodated with clear access to the system.
- During routine servicing, the following items are checked if applicable:

Checks	Procedures
The general condition of the pump chamber supplying the TERO module is good.	The vents in the pump chamber are cleared.
The distribution pipe network inside the module is inspected.	The perforation holes are cleared of any blockages. Shield caps are in place.
Condition of Coconut Fibre is inspected	Correct level of media present. Saturation level checked.
The system is inspected for any obvious non-wastewater infiltration into any compartment.	
General appearance and condition of the treatment system and the surrounding ground area is good.	

10.2 Regular Maintenance of Relating systems

10.2.1 Waste Water Treatment Plant

- The waste water treatment plant should be inspected a minimum of once a year and de-sludged when required. The sludge level should never be more than 50% of the depth of the liquid.
- The vent around the base of the blower housing guarantees a fresh supply of air to the air blower. All vents should be checked to make sure they are not blocked or obscured.
- The vent under the de-sludging cover allows gas to escape and stops the tank from becoming pressurised.
- Ensure the air blower is working by listening for a gentle hum when standing beside the plant.
- The inlet and outlet should be inspected and rodded to remove any blockages if necessary.
- Ensure that no storm or surface water enters the system.
- The wastewater treatment plant should be serviced once a year or as per the manufacturer's instructions.

10.2.2 Pump Chamber (If applicable)

The pump chamber should be inspected annually and the following checks and procedures should be followed:

- Remove the manhole cover and de-sludge tank if necessary.
- Turn up the high-level alarm float switch and check that the alarm light flashes in the control panel.
- Clean the high-level alarm float switch if necessary.
- Ensure that the high-level alarm float switch is positioned correctly to ensure correct operation.
- Check the position of the pump to ensure that the control float has free movement within the pump chamber.

10.2.3 Control Panel

Depending on the Waste water treatment plant used with the Tricel TERO, it is possible that there will be a control panel contained within the WWTP. Regular maintenance of the control panel is recommended. Refer to manufacturer's guide for servicing requirements and procedures. Respond to alarm conditions promptly.

10.3 De-sludging

To ensure that the Tricel TERO system performs effectively, the waste water treatment plant must receive regularly maintenance.

- The de-sludging must be performed by qualified personnel. De-sludging is done with a vacuum tanker (we recommend the use of a licensed company).
- Please remove all floating and settled sludge from the primary chamber of the wastewater treatment plant during de-sludging.

11 Operating Conditions

Warning

Before installing/operating the Tricel TERO system, please read this manual in its entirety, paying special attention to the section entitled 'Health and Safety Precautions'. Normal health and safety precautions should be adhered to at all times, as well as the appropriate procedures to avoid the occurrence of accidents.

The manufacturer's installation, operation and maintenance instructions outlined in this manual must be followed at all times to ensure the system operates as designed. Any variations to these guidelines could result in the unit not performing to its full potential and the discharge may not meet the required standards. The property owner has a legal responsibility to ensure that the system does not cause pollution, a health hazard or nuisance.

11.1 Conditions:

- De-sludging is a critical part of the successful operation of the Tricel TERO system and is the responsibility of the customer. Only competent and approved personnel should carry out de-sludging. De-sludging must be carried out when required as specified, and the system should be inspected regularly to check the depth of sludge in the primary chamber. If de-sludging is required it should be done as soon as possible.
- The Tricel TERO system is one part of the overall wastewater treatment system, which includes many components (plumbing, ventilation, plant and polishing filter). Each component has to function correctly for the overall system to work which is the responsibility of the homeowner.
- If the plant is not installed correctly, flooding, overloading, electrical shock or floatation may occur. We are not responsible for incorrectly installed plants.
- Soakaways, drains and the emptying of primary chamber remains the responsibility of the client. Damage to the installation due to the influx of surface water or the backing up of soak ways or drains is not covered by the manufacturer.

To ensure the continuance of the Tricel TERO system's performance the user has to take certain precautions including the following:

- The design loading of the system should not be exceeded
- High volume discharges, such as those from swimming pools and Jacuzzis must never enter the system.
- Surface water must not enter the system.
- Do not allow large quantities of chemicals to enter the system, including but not limited to:
 - Detergent
 - Water softener
 - Disinfectants
 - Strong acids and alkalis, or photographic chemicals
 - Oil or Grease
 - Petrol or Diesel
 - Pesticides
- Acceptable in normal conditions and usage. Excess amounts of biological detergent can affect the biomass development. If you have to use an unusual amount, it may be a good idea to spread it over a few days.
- In applications that produce large volumes of grease (e.g. commercial kitchens) it is advised that a suitably sized grease trap is installed and maintained effectively to ensure the correct operation of the

Tricel TERO system. Fats or grease present in the system will greatly reduce the operating efficiency of the system and will greatly reduce the life expectancy of the Coconut fibre.

- Generally speaking, all common household cleaning fluids are acceptable, provided they are used in accordance with the maker's instructions and stipulated concentrations.
- Do not allow any of the following to enter the Tricel Puraflo system:
 - Large quantities of milk, alcohol or food
 - Large quantities of bleaches or cleaners
 - Baby wipes, cosmetic and cleaning wipes
 - Sanitary towels
 - Tampons
 - Kitchen paper
 - Nappies
 - Medication
- Service personnel must be accommodated with clear access to the system.
- If others size the system, we will supply to these specifications. In this case, the responsibility lies with others in relation to the maximum flow/litres per day, the system capacity and retention times. Similarly, if we size the system and a greater load is placed on the system by the addition of extra houses, bedrooms, schools, crèche's etc., or by other means, we are not responsible for the system in terms of overloading or quality of effluent as the retention times may be compromised.
- The modules are not suitable for vehicular traffic. We also recommend fencing off the area to prevent livestock herds from accessing the system.
- There must be no load placed on the lids of the TERO module and the lid must not be covered.
- There must be no vegetation planted in the ground adjacent to the TERO module.
- In the event that a non-Tricel approved installer is installing the system, please ensure that the installer has the required skills and knowledge to ensure that the system is installed correctly.

12 Troubleshooting

12.1 Plant Operation

Symptom	Possible causes	Solution
Pump operates but delivers no water to TERO	Low Line voltage or wired incorrectly	An electrician should check the power to the plant.
	Something caught in impellers	Clean out impellers or replace pump. WARNING: Ensure pump is disconnected from the main before you attempt to unclog it.
	Delivery hose blocked	Find blockage and remove or replace damaged hose.
	Other pump malfunction	Pump must be checked by a qualified person.
Module becomes flooded	Discharge outlets blocked	Find blockage and remove or replace damaged hose/pipe.
	Storm water flooding	Redirect storm water drains. Storm water must never enter the plant.
	Float from the pump is stuck	Ensure the float on the pump is set correctly and can move freely.
	Pump not working	Check pump is functioning properly as above.

12.2 Odours

When the Tricel Puraflo system is correctly installed and operated there should be no strong odour in the area adjacent to the system. The presence of a strong odour would indicate that the plant is not working effectively.

NOTE: Before taking any corrective action, always positively identify the real source of the odour. Check if the odour is coming from another outside source such as a storm drain. All wastewater treatment plants vent gases back through soil pipe and out roof vents. Improperly installed roof vents can cause odour problems. Traps in drains prevent odours from entering the home. To function they must contain water and be sealed correctly.

Odour Locations	Cause	Solution
Strong effluent odour directly outside the house or inside the house	Pipe connections to toilets/drains not connected correctly	Check that the traps/U - bends in the drains are fitted and the joints sealed.
	Air vent on pipe work not installed correctly.	Ensure all effluent pipes are vented correctly. Vents are normally fitted to all pipes.
	Pipe work is damaged, blocked or not installed correctly	Inspect pipe work to ensure it is undamaged and clear of obstructions or sagging.
	Septic tank effluent filter blocked (located at septic tank outlet).	Clean filter with hose.
Strong effluent odour directly over the system	Pipe work to or from the septic tank is blocked.	Check the level of wastewater in the tank. Ensure the pipes are not blocked and are installed correctly to the tank.
	Chemical kill of bacteria.	Empty the tanks and fill with fresh water
	No oxygen entering the tank.	Clear any blockages in the vents
	Too much grease entering the plant.	Install/empty grease trap.
	Coconut fibre level/quantity inside the modules are low.	Arrange a replacement of the Coconut fibre.

In accordance with our normal policy of product development, this specification is subject to change without notice.

13 Certification

13.1 Tricel TERO

Tricel TERO Modules tested to EN12566 Part 7, can be used in conjunction with a Wastewater Treatment Plant tested to EN12566-3 with 98.5% hydraulic efficiency.



Certificate

Nr. 438.01C04

Coconut Fibre Tero System

Tertiary treatment unit

TRICEL (Killarney) Unlimited Company
Ballyspillane Ind. Est., Killarney, Co. Kerry, Ireland

EN 12566-7:2013, Annex A

Small wastewater treatment systems for up to 50 PT – Part 7:
Prefabricated tertiary treatment units

Only valid in combination with test report PIA2023-T7-438S23.
This certificate replaces certificate no. 438.01C03.



Evaluation according to EN 12566-7, Annex A

Organic daily load (influent) 0.01 kg BOD₅/d
Hydraulic daily load 0.90 m³/d

Tank material PE

Treatment efficiency	Efficiency	Effluent
COD	- 67.6 %	54 mg/l
BOD ₅	37.8 %	5 mg/l
TN _b *	18.2 %	24.0 mg/l
NH ₄ -N*	95.7 %	0.2 mg/l
SS	64.4 %	4 mg/l

Electrical consumption (Nominal) 0.2 kWh/d
Number of desludging (complete test) 0
Number of maintenance operations during the test (without start-up phase) 0

* determined for temperatures $\geq 12^\circ \text{C}$ in the bioreactor

Tested by:
PIA – Prüfinstitut für Abwassertechnik GmbH
Hergenrather Weg 30
52074 Aachen, Germany

This document replaces neither the declaration of performance nor the CE marking.
The results relate only to the tested object.

PIA – Sustainable Certification
[Signature]
geprüft – getestet – teste

January 2024, Dipl.-Ing. Gabriel Schatzki
Head of department "Wastewater Treatment"



Notified Body
No.: 1739



Certified according to
ISO 9001:2015



Attestation

Nr. 438.01A01

Coconut Fibre Tero System

Tertiary treatment unit

TRICEL (Killarney) Unlimited Company
Ballyspillane Ind. Est., Killarney, Co. Kerry, Ireland



Over a test period of 6 weeks (4 weeks nominal load, 2 weeks 50 % of nominal load), flow-proportional 24-hour composite samples were taken weekly (influent and effluent). The Tero was fed from a pump shaft which was connected to a small wastewater treatment plant (gravity flow mode). Dosing to the module took place in 20 litre portions and a flow of approx. 1 litre/s. Microbiological samples (E. coli) were taken as grab samples.

Performance details

Organic daily load (influent, nominal)	0.06 kg BOD ₅ /d			
Hydraulic daily load (nominal)	0.9 m ³ /d			
Treatment efficiency (nominal)		Efficiency (nominal / underload)	Effluent (nominal / underload)	
		COD	-39.0 % / -133.8 %	73 mg/l / 78 mg/l
		BOD ₅	59.9 % / 39.3 %	6 mg/l / 5 mg/l
		TN _b *	18.2 % / -	25.8 mg/l / -
		NH ₄ -N*	95.5 % / -	0.2 mg/l / -
		SS	78.4 % / 73.6 %	4 mg/l / 3mg/l
		E.Coli	99.3 % / 97.5 %	643 / 591 CFU/100 ml
Electrical consumption (nominal)	0.15 kWh/d			
Number of desludging (complete test – 6 weeks)	0			
Number of maintenance operations during the test	0			

* determined for temperatures $\geq 12^{\circ}$ C in the bioreactor

Tested by:
PIA – Prüfinstitut für Abwassertechnik GmbH
Hergenrather Weg 30
52074 Aachen, Germany

This document is for information purposes only.
The results relate only to the tested object.



February 2024, Dipl.-Ing. Gabriel Schatzki
Head of department "Wastewater Treatment"



Notified Body
No.: 1739



Certified according to
ISO 9001:2015

Tero Module System	This Unit is a (mark "X")
One Module	
Two Module	
Three Module	
Four Module	
Five Module	
Six Module	
Seven Module	
Eight Module	
Nine Module	



Tricel (**Killarney**) Unlimited Company Trading as Tricel
 Ballyspillane Ind. Est. Killarney, Co. Kerry, Ireland
Tel: +353 (0)64 663 2421 | **Email:** sales@tricel.ie | www.tricel.ie

In accordance with Tricel's normal policy of product development these specifications are subject to change without notice.