

Tricel Domestic & Light Commercial Pumping Chambers

Wastewater Treatment Plants

Engineering a green future



Contents

1	Health & Safety Precautions.....	4
1.1	General	4
1.2	Electrical /Maintenance	4
1.3	Installation	4
2	Introduction: Tricel Pumping Chamber.....	5
3	Tricel Pumping Chamber Range	6
3.1	Dimensions	6
3.2	Tank Drawings	6
3.3	Dual Pump Systems	8
4	Transportation & Lifting	9
4.1	Lifting tanks up to 4.6m long.....	10
5	Installation	10
5.1	Installation Planning.....	10
5.2	Inspection on reception of tanks.....	11
5.3	Positioning and precautions	11
5.4	Types of Installation	11
5.5	Installation Procedure	12
5.5.1	Excavation (Dry & Wet Sites).....	12
5.5.2	Installation – Step by Step Guide.....	13
5.6	Gravel Specification	14
5.7	Concrete Specification	15
5.8	Topsoil Requirements	16
5.9	Risers	16
5.10	Non-Standard Installations	17
5.10.1	Alternative to Concrete Backfill (For Wet Sites Without Risers Only).....	17
5.10.2	Sloping ground	17
5.10.3	Proximity to rolling & static loads.....	18
5.11	Electrical Requirements	18
5.11.1	Wiring Procedure:	19
5.12	Plumbing the Tricel Pumping Chamber	21
6	Pump Specifications.....	22
6.1	Tricel 75.....	22
6.1.1	Operating Performance: Tricel 75.....	23
6.2	Domo GRI 11	25
6.2.1	Operating Performance: GRI 11.....	26

6.3	High-Level Float.....	27
6.4	Non-Return Valve.....	28
7	Plant Operation.....	28
8	Disposal of Treated Water.....	29
9	Maintenance.....	29
9.1	Regular Maintenance.....	29
9.2	Annual Maintenance.....	29
9.3	Annual Service(Availablefromyoursupplier).....	29
9.4	De-sludging (Emptying the solid waste from the pumping chamber).....	30
10	Operating Conditions.....	30
10.1	Conditions.....	30
11	Troubleshooting.....	32
11.1	Plant Operation.....	32
11.2	Odours.....	33
12	Terms & Conditions.....	34

1 Health & Safety Precautions

It is important to read the full technical manual prior to installation. This document should be retained for the lifetime of the product and in the event of change of ownership be transferred to the new owner. As safety and security are of vital importance, the following aspects are critical:

1.1 General

- Ensure that all the information contained in this manual is adhered to at all times.
- It's important that locks are fitted to the lid to prevent accidental access.
- Manholes are rated to 125kg and are for pedestrian use only.
- Never enter a tank, unless qualified to do so.
- Naked flames shall not be used in the vicinity of the tank due to the danger of combustion.
- The manhole covers shall never be left off an unattended tank. Always lock the cover of the plant when work is completed.
- Sewage and sewage effluent can carry micro-organisms and gases harmful to human health. Any person carrying out work on the plant must be appropriately trained. Suitable protective clothing; including gloves, goggles should be worn at all times. Always remove contaminated clothing and protective equipment after working with sewage treatment plants. Wash hands and face prior to eating, drinking or smoking.
- All access hatches must be locked for safety. Tanks are supplied with 3 locking points, as shown below. All these points should be locked with a suitable locking device to prevent unauthorised access. Locking devices are not supplied.



1.2 Electrical /Maintenance

- All electrical work to be carried out by a qualified electrician using suitable materials for the application.
- Do not open the Tricel Pumping Chamber's cover without firstly isolating the mains power.
- Electrical work must be carried out strictly to the manufacturer's instructions and to the relevant national rules for electrical installations.
- When working with machinery / electrical equipment, proximity of water shall be noted. Electrical equipment shall not be wet when working with it.
- There is potential danger when de-sludging and therefore this shall never be done alone.

1.3 Installation

- Excavation work should be planned with due regard to health and safety requirements.
- Prior to installation, please consider finished ground level when installing the Tricel Pumping Chamber. If you envisage that a manhole riser/extension may be required to ensure manhole lid remains above finished ground level, the Tricel Pumping Chamber must be installed with the appropriate excavation foundation and backfill to accommodate the riser. Please refer to Section 5.9.
- Excavated material should either be shored or battened back to a "safe" angle.

- Use appropriate lifting equipment.
- Care should be taken around ground work machinery.
- Keep proper footing and balance at all time.

2 Introduction: Tricel Pumping Chamber

Tricel Pumping Chambers are manufactured from Sheet Moulding Compound (SMC). Sheet moulding compound (SMC) resin is a fiberglass-based compression moulding that is used in applications that require high strength and durability.

Tricel pumping chambers are suitable for domestic and light commercial applications and used where gravity drainage is not possible. The Tricel Pumping Chamber comes with a Tricel 75 pump as standard for treated effluent and a GRI11 for raw sewage. The GRI 11 pump is also available if greater distances or a higher head is required.

The tank is constructed from GRP and collects the effluent or foul water from low-lying developments and pumps to the discharge point at a higher level e.g. main sewer, treatment plant or percolation area. The pump in the pumping chamber is fitted with a control float, which activates the pump when the capacity has reached a pre-defined level. There is a high-level float which is connected to an alarm. If this float rises the alarm will activate alerting the home owner to possible pump failure or blockage.



3 Tricel Pumping Chamber Range

3.1 Dimensions

Tricel Pumping Chamber		2600	4000
Nominal Capacity	litres	2612	4136
Nominal inlet pipe diameter	mm	110	110
Nominal outlet pipe diameter	mm	38	38
Overall length	m	1.6	2.6
Overall width	m	1.64	1.64
Overall height	m	2.56	2.56
Inlet invert to base	m	1.375	1.375
Outlet invert to base	m	1.67	1.67
Inlet invert to ground level	m	0.535	0.535
Outlet invert to ground level	m	0.250	0.250
Height above ground level	m	0.33	0.33
Weight empty*	kg	200	300
Standard volume pumped per cycle	litres	195	336
Standard volume after alarm goes off	litres	950	1600

*Allow 100kgs extra for lifting purposes.

3.2 Tank Drawings

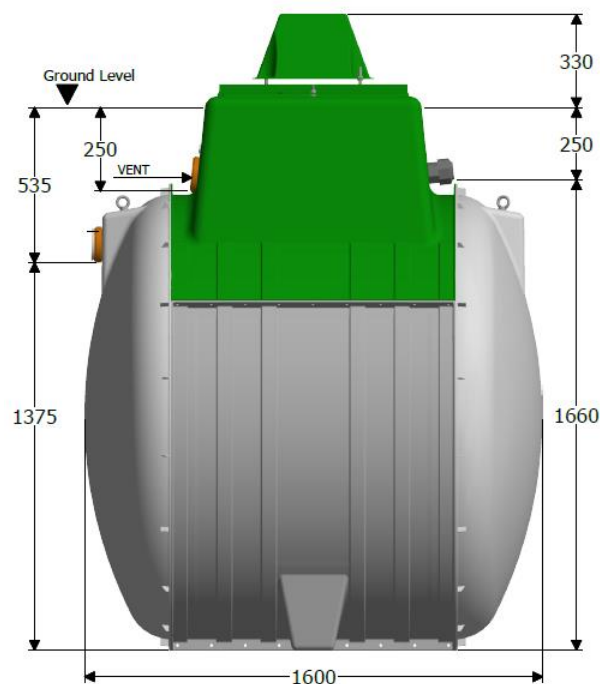

2600L Pumping Chamber

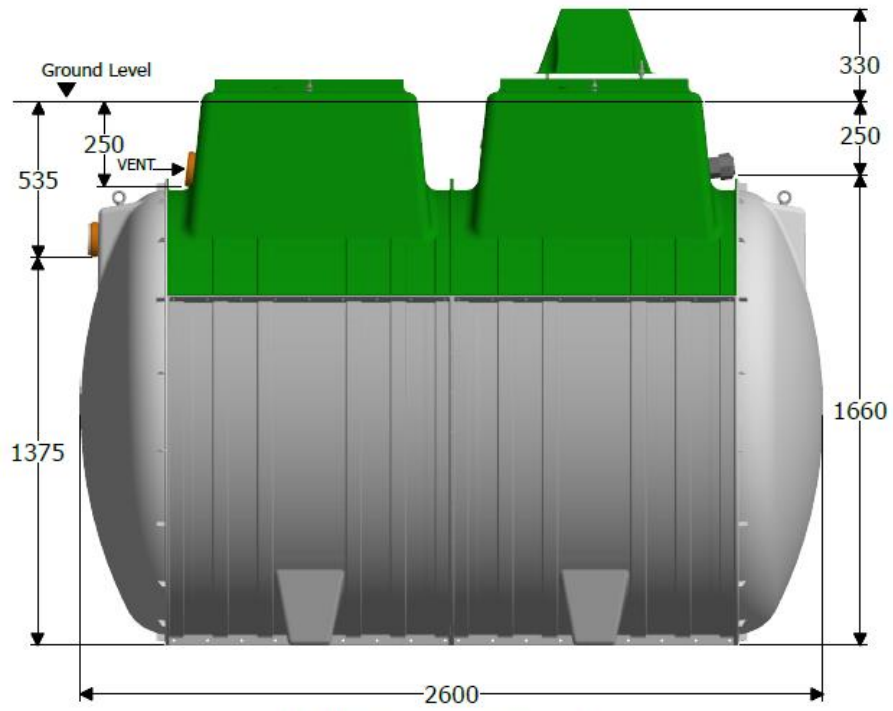

4000L Pumping Chamber

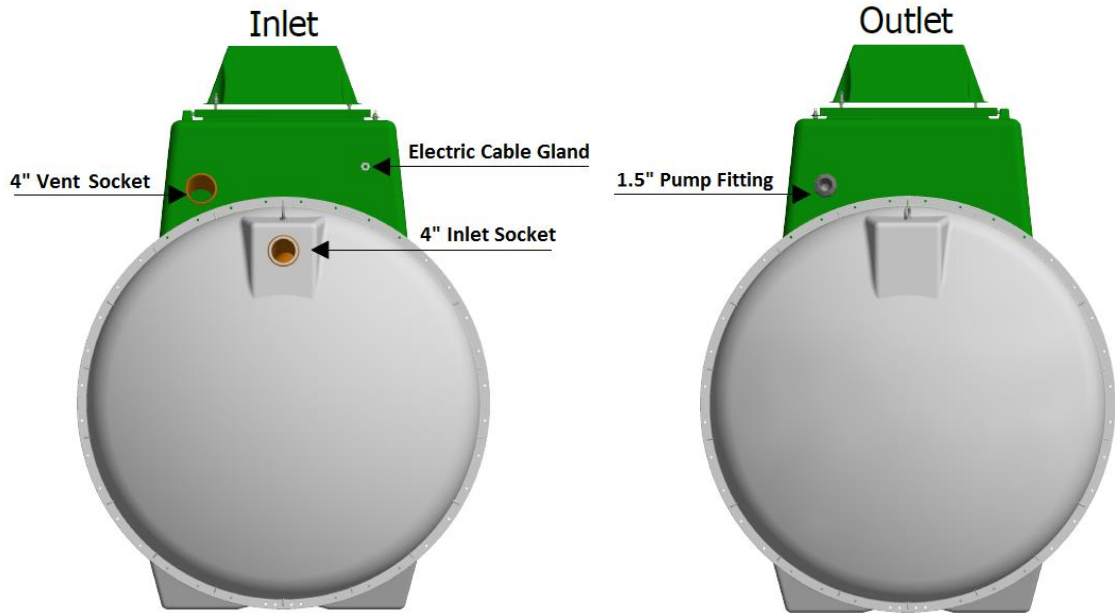

3.3 Dual Pump Systems

Tricel Pumping chambers may be supplied with a backup pump in case of pump failure. In this case the two pumps would alternate by means of a flip flop control panel to prolong the lifespan of the pumps. These systems are fitted with non-return valves. Dual pump systems are available on request.



4 Transportation & Lifting

- Tanks must be held down during transportation using nylon straps, do not use cables or chains to secure tanks. Do not overtighten straps that can result in deformation of the tank shell. Do not drop or roll tanks from the truck.
- Move tanks only by lifting and setting, do not drag or roll.



- Always set the tank(s) on flat smooth ground clear of debris etc. To prevent movement, tanks may need to be tied down and chocked. Position the chocks in the locations shown below:

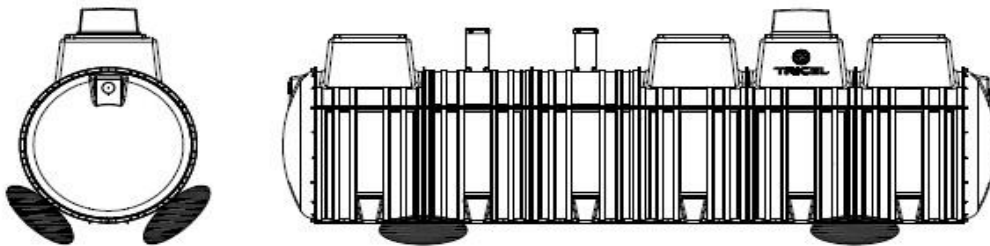

- Tanks are best lifted by a machine and webbing lifting straps – do not use chains or wire ropes in contact with the tank.
- Ensure tank is empty when lifting.
- Care is needed to control the lift to ensure the tank is not damaged.
- Ensure the slings are positioned at a joint on the tank, firmly secured and the load is evenly balanced.

4.1 Lifting tanks up to 4.6m long

- Tanks up to 4.6m in length should be lifted using the eyebolts on the tank.
- Tanks up to 4.6m in length can be lifted using only lifting straps, as shown in Option 1. However, on sites where lifting height is restricted, a lifting bar should be used as shown in Option 2:

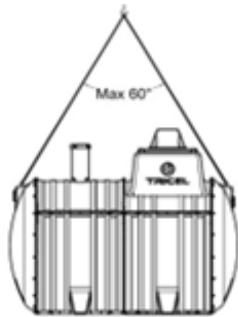

Option 1

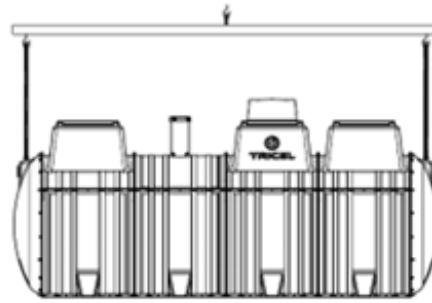

Option 2

- To ensure the angle of the sling is not greater than 60°, as per option 1 above, the following sling lengths are required:

Length of tank	Minimum length of sling
1.6	1.6
2.6	2.6

5 Installation

5.1 Installation Planning

Important

Prior to the installation of the Tricel Pumping Chamber, it is important to carefully read these installation instructions.

- When planning the installation of a Tricel Pumping Chamber, the following must be considered:
Backfill Considerations:
 - Is this a dry or wet site i.e. presence of a water table?
 - Which backfill material is appropriate for this site?
 - What is the finished ground level and will risers be required?
Note: If a riser is required, the installation may require a concrete backfill. If unsure of the finished ground level, always use a concrete backfill as risers greater than 250mm cannot be retrofitted without a concrete backfill.

Site Considerations:

- Is the site restricted in terms of area or height?
 - What is the topography of the site i.e. being it sloping or flat?
 - What is the proposed depth of the installed tank to ensure the required slope upstream?
 - Are static or rolling loads present on this site?
- Only suitably qualified personnel should perform the installation of the Tricel Pumping Chamber.
 - Suitably sized equipment will be required to excavate the hole and to lift the Tricel Pumping Chamber into place.

5.2 Inspection on reception of tanks

- Tanks should be visually inspected for damage which may have occurred during transport prior to installation. Any damage should be notified to the delivery driver and/or to your supplier. Do not attempt to carry out any unauthorized repairs, as this will invalidate the warranty on the tank.
- Once the tank has been installed, Tricel cannot accept any claims for damage.

5.3 Positioning and precautions

- The Tricel Pumping Chamber must be situated a minimum of 7m from the dwelling and should be as far away as practically possible considering topography and pipe work levels.
- The Tricel Pumping Chamber should not be installed in an area subject to flooding or excessive water runoff as no flood waters should enter the tank.
- The area around the Tricel Pumping Chamber should be adequately drained, to permanently remove ground water and surface water from the proximity of the tank.
- The Tricel Pumping Chamber plant is not suitable to be used in water logged sites, where the ground water may rise above the inlet pipe.
- When selecting the location of the Tricel Pumping Chamber, ensure that it is always accessible for future maintenance.

5.4 Types of Installation

All installations must be "fit for purpose" to suit the on-site conditions, which will vary from site to site. This is the responsibility of the onsite contractor.

When installing a Pumping Chamber, there are two types of standard installation method:

1. **Gravel Installation**
2. **Concrete Installation**

Two factors must be considered when determining which installation must be implemented:

1. **Is the Tricel Pumping Chamber being installed in a 'Dry Site' or a 'Wet Site'?**
 - A 'Dry Site' is a site in which the water table never rises higher than 300mm from the base of the tank.

- A 'Wet Site' is a site in which the water table may rise higher than 300mm from the base of the tank. Tricel strongly advise the installation of a vertical water table inspection pipe. This will facilitate convenient monitoring of the water table long after the installation is completed.

Note: In difficult soils (e.g. clay with a high t-value), a site could be potentially classified as wet if there is no drainage for surface water that enters the excavation and it rises higher than 300mm above the base of the unit. The installer must determine this when selecting the correct backfill.

2. Is a riser required, and if yes, what height riser must be installed? (For more information on risers, please see Section 5.9).

The following table specifies the required installation for on-site conditions:

Factors that determine the required installation		Installation Required
Type of Site	Riser Required	
Dry	None	Gravel
Dry	250mm	Gravel
Dry	500mm & 750mm	Concrete
Wet	None	Concrete
Wet	250mm, 500mm & 750mm	Concrete

Important

- Incorrectly installed tanks that are subject to movement, rotation or floatation may become damaged, for which Tricel cannot accept liability.
- During installation, tanks must not be subjected to buoyant forces.
- Contact a qualified engineer if there are difficulties on site due to adverse water logging.
- Ballasting the tank is important to avoid the tank from lifting when backfilling.

5.5 Installation Procedure

5.5.1 Excavation (Dry & Wet Sites)

5.5.1.1 Excavation: Length & Width

Length and width of the excavation must exceed the dimensions of the Tricel Pumping Chamber by at least 500mm to maintain a minimum space of 250mm all around the tank.

Tricel Pumping Chamber	Tank Length (m)	Tank Width (m)	Min. Excavation Size (L x W) (m)
2600	1.6	1.64	2.1 x 2.14
4000	2.6	1.64	3.1 x 2.14

Note: The size of the area to be excavated applies to both dry and wet sites, however, unstable ground with excessive sand, peat swamps etc. may require larger excavations. The excavation should be maintained dry by pumping or whatever suitable means.

5.5.1.2 Excavation: Depth

The excavation depth is determined by the inlet and outlet pipes, invert levels relative to the bottom of the tank, and allowing for the minimum base thickness. Dimension details of the tank are shown on the relevant drawing, see Section 3.2. Ground instability e.g. running sand may necessitate over-excavation and stabilization with hard core or blinding concrete. The depth of the excavation for both gravel and concrete installations are outlined as follows:

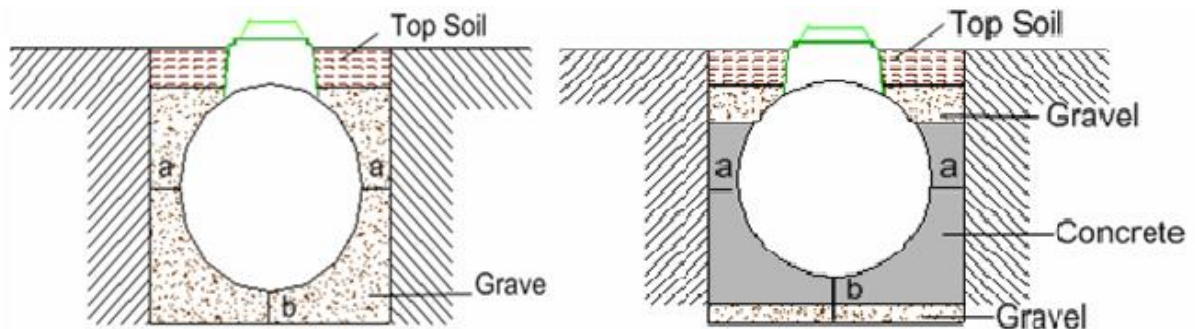

	Tank Width (mm)	"a" minimum (mm)	"b" minimum (mm)
Dry Site	1640	250	250
Wet Site	1640	250	300*

* includes 50mm gravel and 250mm concrete.

5.5.2 Installation – Step by Step Guide

Steps	Installation Required		
	Gravel	Concrete	
Installation of the tank base/plinth:	1	Remove any soft spots or large stones and boulders.	
	2	The base is constructed of a 250mm layer of suitably compacted gravel.	The base is constructed of a 50mm layer of suitably compacted gravel, covered with a 250mm layer of semi dry concrete.
	3	Ensure that base is level and at the correct height to accommodate the incoming pipe work.	
	4		It is important to maintain a completely dry excavation until the final pour of concrete is set. It may be necessary to line the excavation with a continuous layer of 1200-gauge polythene to maintain the integrity of the concrete.
Positioning of tank onto	5	Mechanically lift the pumping chamber carefully into the centre of the hole and place on the prepared plinth.	Mechanically lift the pumping chamber carefully into the centre of the hole.

the base/plinth:	6	The plant must sit level on the plinth.	
	7	Connect and seal the pipe work to the tank.	
Backfilling around the tank:	8	Ballast the plant by filling each chamber with clean water to a depth of 300mm and recheck the pipe work levels.	
	9	Commence backfilling with gravel in layers of 225mm evenly around the tank ensuring that there are no voids until gravel has reached 50mm over the cylindrical body of the tank. Compact each layer in succession. *	Commence backfilling evenly in layers of 225mm around the tank, ensuring that there are no voids, until it has reached the invert of the outlet pipe. Continue backfilling with gravel, until it has reached 50mm over the cylindrical body of the tank. *
	<i>Note:</i>		
	<i>* Continue filling the chambers with water whilst backfilling, ensure that the progressive water level is no more than 300mm above the backfill level.</i>		
	10	Mount and seal manhole risers (if used). Please see 'Riser' section.	
	11	Complete backfilling with topsoil up to the max ground level. Allow for subsequent settlement of topsoil.	
<i>Note:</i>			
<i>The use of geo textile barrier fabrics over the gravel backfill is considered good installation practice. The fabric must be chosen to allow the flow of water in and out of the excavation but to prevent the movement of fine soil particles into the gravel backfill.</i>			

Important

The plumbing to and from the plant should be completed by a competent person in accordance with national regulations and best practices.

5.6 Gravel Specification

Primary backfill specification

Primary backfill material should be free-flowing granular material. Compaction should be by lightweight rollers or vibratory plate compactor until "traffic" depth has been achieved. Compact gravel evenly to ensure tank is properly supported. Ensure the vibrating machine does not come in contact with the shell of the tank. Tanks must be installed with primary backfill only within the region immediately surrounding the tanks. This primary backfill must extend a minimum of 250mm outward from the tank, and directly beneath the tank.

The following materials are approved as primary backfill:

Rounded pea gravel

- Minimum particle size 3mm, maximum 18 mm, compacted to a relative density of >70%. Gravel shall be clean and free flowing, free from large rocks, dirt, sand, roots, organic materials or debris. Upon screening analysis, the backfill material shall have no more than 5% by weight passing 2.36 mm Sieve

Or

Crushed or processed stone

- Minimum particle size 3 mm, maximum 12 mm, compacted to a relative density of >40%
- Dry Gravel density must be at least 1500 kg/m³. Material should be washed or screened to remove fine particles.
- Upon screening analysis, the backfill material shall have no more than 5% by weight passing 2.36 mm sieve.
- Use of other than specified backfill and bedding materials will void the tank warranty.
- Backfill material shall not be frozen or contain lumps of frozen material at any time during placement.

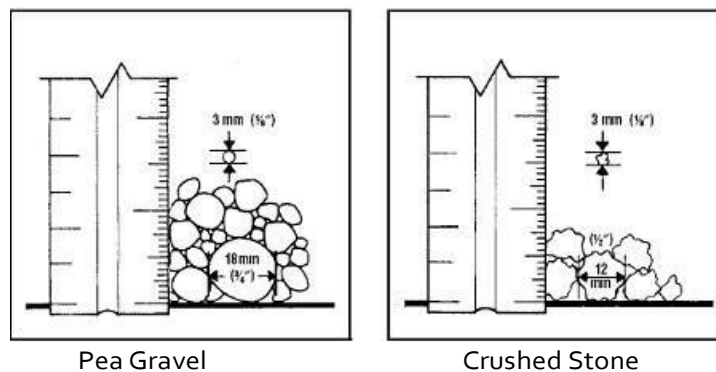

5.7 Concrete Specification

Semi dry concrete 25n grade with a ratio of 4.5 aggregate to 1 cement.

Important:

- Standard concrete mixes should not be used, where sulphates or similarly aggressive chemicals are present in the groundwater.
- **Lift height (rate of rise):** Determine the lift height (m), or rate of rise (m/h) for the specific concrete type used, to ensure that a design pressure (P max) of 15kN/m² on the tank is not exceeded.
- **Vibration:** The tank design assumes minimal compaction of the surrounding concrete. Where necessary, this may be extended to include light internal vibration. Never use deep revibration which will substantially increase the pressure on the tank, possibly causing failure.
- **Impact of concrete on discharge:** Under no circumstances should concrete be discharged directly onto the tank.

5.8 Topsoil Requirements

Clean native top soil shall not contain rocks larger than 36mm on largest dimension.

5.9 Risers

In the event that a Tricel Pumping Chamber requires a deeper than standard installation to align with the wastewater outlet pipe from the dwelling, manhole risers are available for deeper installations to avoid the access hatch being positioning in a depression, as shown in the diagram:

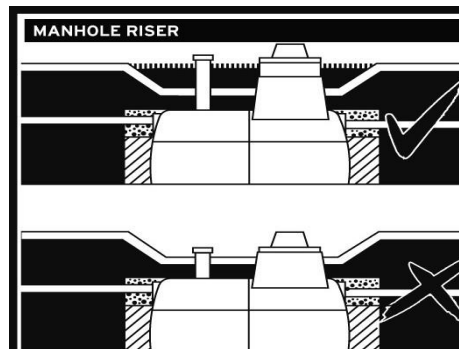

Risers are available in the following sizes:

- **250mm** (requires installation suitable for the site conditions)
- **500mm** (requires a concrete backfill) *
- **750mm** (requires a concrete backfill) *

**500mm and 750mm risers cannot be retrofitted unless the correct installation is in place.*

- The Tricel Pumping Chamber is suitable for a maximum manhole riser of 750mm which gives a maximum inlet invert of 1310mm, as shown below. The Tricel Pumping Chamber is not suitable where a deeper installation is required.

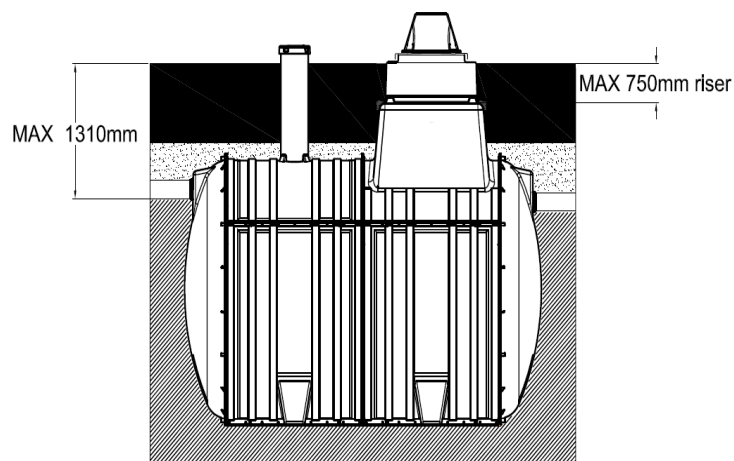

Important:

- Never place the access covers below ground level.
- Only Tricel access covers must be used.
- Do not allow ground water or storm water to enter the pumping chamber.

5.10 Non-Standard Installations

5.10.1 Alternative to Concrete Backfill (For Wet Sites Without Risers Only)

- The option of securing the Tricel Pumping Chamber to a reinforced concrete slab or Deadman anchor by way of straps may also be used, as shown below:



- **Tricel accepts no responsibility for the design of the concrete slab/Deadman anchor.** This solution should be designed by an on-site structural engineer to suit site conditions.
- The straps should be positioned as close to the bolted joints as possible.
- The reinforced concrete slab/ Deadman anchor must be installed after the level of the ground water has been lowered, if necessary.
- Once the Tricel Pumping Chamber has been secured by the straps, the backfilling with concrete or gravel can commence.

5.10.2 Sloping ground

When the slope of the ground is 5% or more, it is recommended to install a retaining wall to protect the tank from lateral thrust. Concrete backfill may also in some cases be sufficient to protect the tank. A qualified structural engineer must determine if a retaining wall is required in the presence of a steep slope as shown in the picture below:



5.10.3 Proximity to rolling & static loads

Minimum separation distances from:

- Rolling Loads (e.g. vehicle traffic): 4 metres
- Static Loads (e.g. dwelling house, shed): 3 metres

If the tank is installed in an area where traffic or other superimposed loadings can be applied, consult a structural engineer for the design of a reinforced concrete slab to prevent the load being transmitted to the tank (or its concrete surround). If this slab is constructed immediately above the tank, it should be separated from the concrete surrounding the tank by a compressible material.

5.11 Electrical Requirements

Important:
<ul style="list-style-type: none">• Please ensure the electrical installation complies with all national regulations and requirements.• Electrical installations must be carried out by a qualified and certified electrician.• A wiring label is located on the inside of the alarm box.

The customers' minimum responsibility shall consist in the provision of:

- The type and size of the power supply cable must comply with all national regulations and requirements. The specification of the cable is the responsibility of a qualified electrician.
Note: In typical domestic installations, a single run of 1.5mm² 3 core (two conductors plus earth conductor) steel wire armoured (SWA) cable from the customer's distribution cabinet to the tank unit socket box is required.
- The system should have its own circuit with cable protection via 10-amp MCB protected by (RCD), rated 230V, 30mA.
- The cable must be properly bonded to the main earth in line with current wiring regulations.
- Never disconnect the power to the pump. It is imperative that it is running 24 hours a day, every day.

5.11.1 Wiring Procedure:

- Wire the float into the alarm panel.
- First crimp the brown and black cores.
- Put the brown into the second live terminal and the black into terminal L. See Figures below:

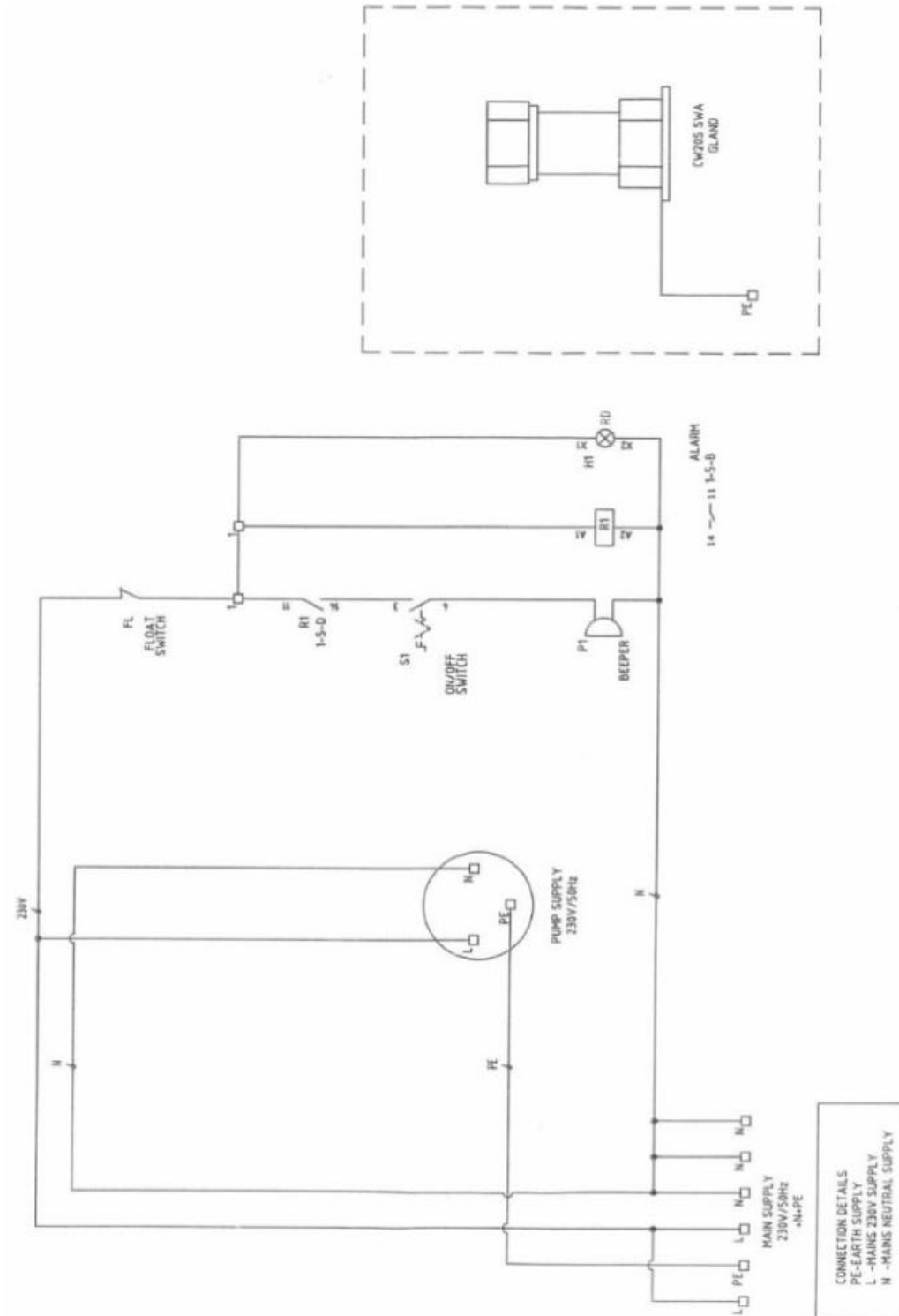

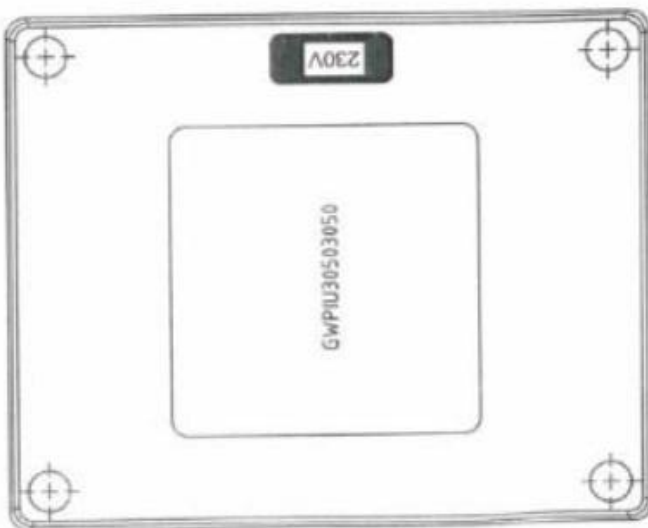
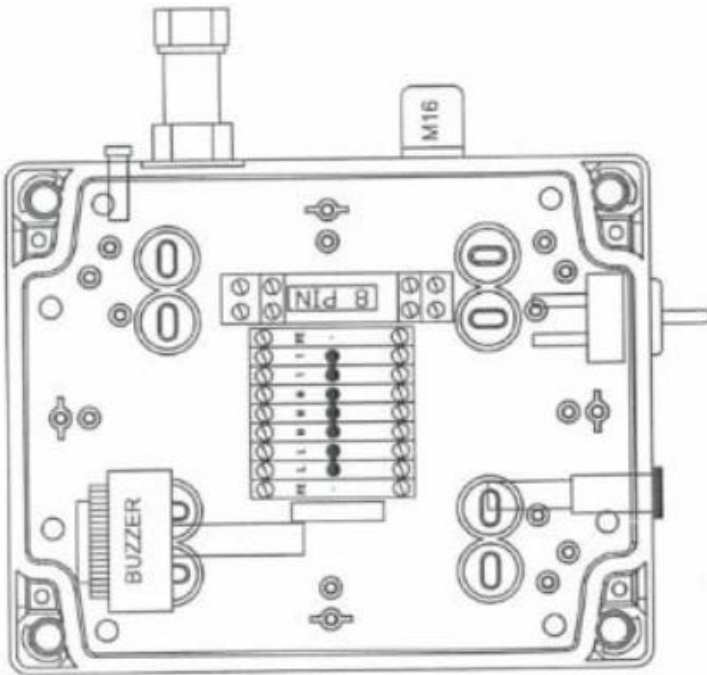
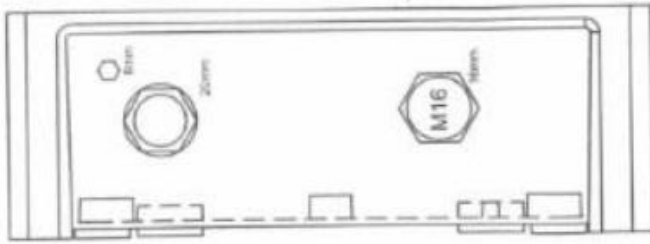

5.12 Plumbing the Tricel Pumping Chamber

The plumbing to and from the plant should be completed by a competent person in accordance with national regulations and best practices.

The Tricel Pumping Chamber with a **Tricel 75 pump and Domo GRI 11 pump** will have a 1 ½ Inch outlet (Philmac compression fitting). The inlet to the pumping chamber will be a 4-inch pipe socket. A 4-inch sewer pipe is plumbed from the house to the tank with a fall to the tank so sewerage will flow into the pumping chamber. Ensure the pipework is fitted with the correct fall to ensure there are no blockages. A 1 ½ Inch hydrodare pipe will be connected to the 1 ½ Inch outlet (Philmac compression fitting) on the tank.

The inlet to the pumping chamber will be a 4-inch pipe socket. A 4-inch sewer pipe is plumbed from the house to the tank with a fall to the tank so sewage will flow into the pumping chamber. Ensure the pipework is fitted with the correct fall to ensure there are no blockages.

There is a 4-inch socket on the side of the turret where a vent pipe must be connected to. This 4-inch vent pipe is brought above the surface at a suitable location. A 4-inch vent cover/cowl is to be attached to this 4-inch vent pipe to prevent debris falling in. Ensure the pumping chamber is vented correctly to prevent the build-up of smells around the tank.

Grease Trap:

Best practice indicates that a grease trap be fitted before the pumping chamber particularly in applications where high quantities of grease/fat exist in the wastewater.

6 Pump Specifications

There are two different type pumps used in our pumping chambers which are as follows:

- Tricel 75
- Domo GRI 11

6.1 Tricel 75

Tricel 75 is the basic pump which is used to pump wastewater over a short distance with a low head.

The Tricel 75 is capable of handling solids of up to 35mm in diameter. To operate correctly, make sure the On/Off float of the pump can move freely and that it is not snagging against the divider or the side of a tank.



Tricel 75 pump

6.1.1 Operating Performance: Tricel 75

Pump Type	Power		Capacity								
	[KW]	[HP]	l/min	0	40	80	120	160	200	240	300
			m^3	0	2.4	4.8	7.2	9.6	12	14.4	18
H=Total manometric head in metres											
Tricel 75	0.55	0.75		8.8	7.6	6.8	5.7	4.7	3.4	2	0

Tricel | 75 (0.55 kW) – impeller diameter = 100 mm

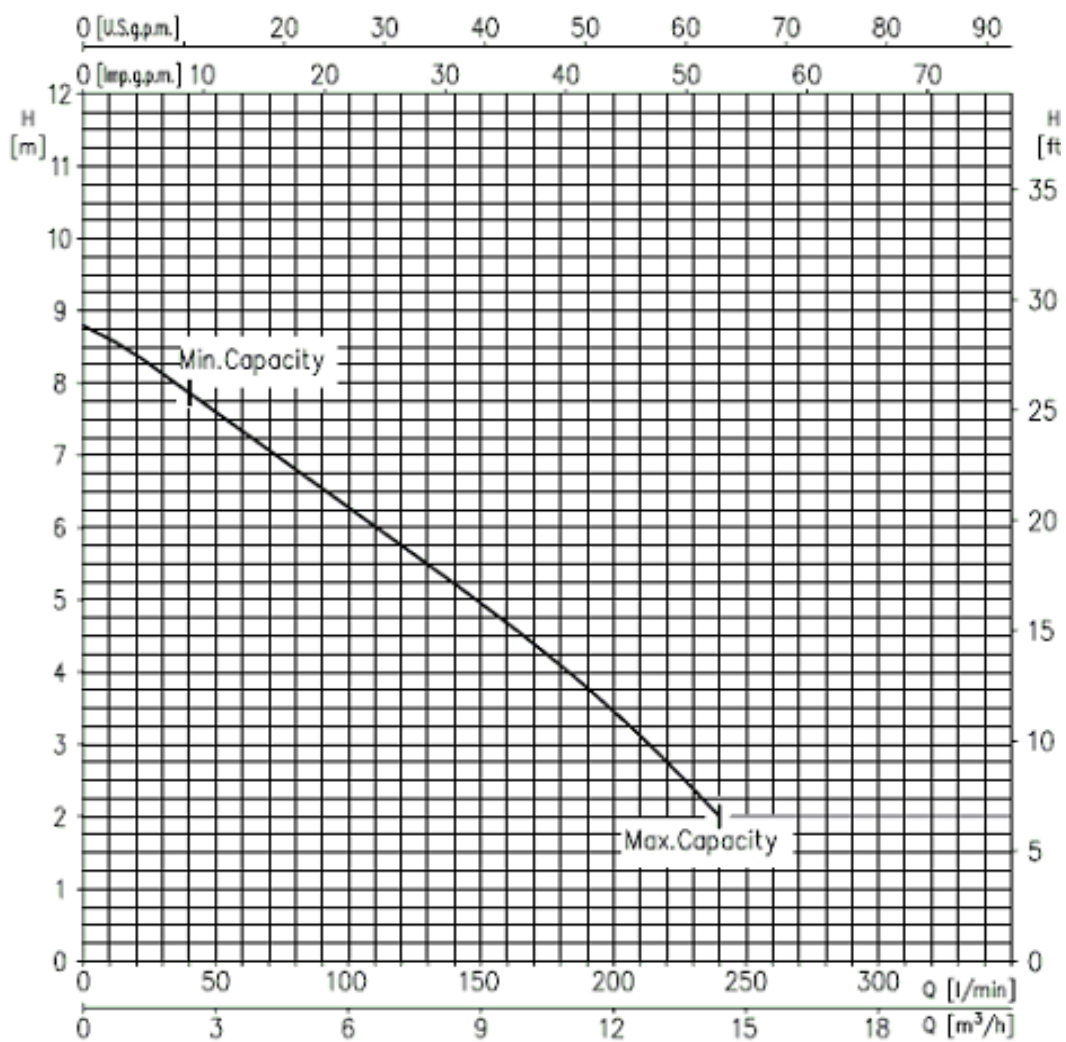

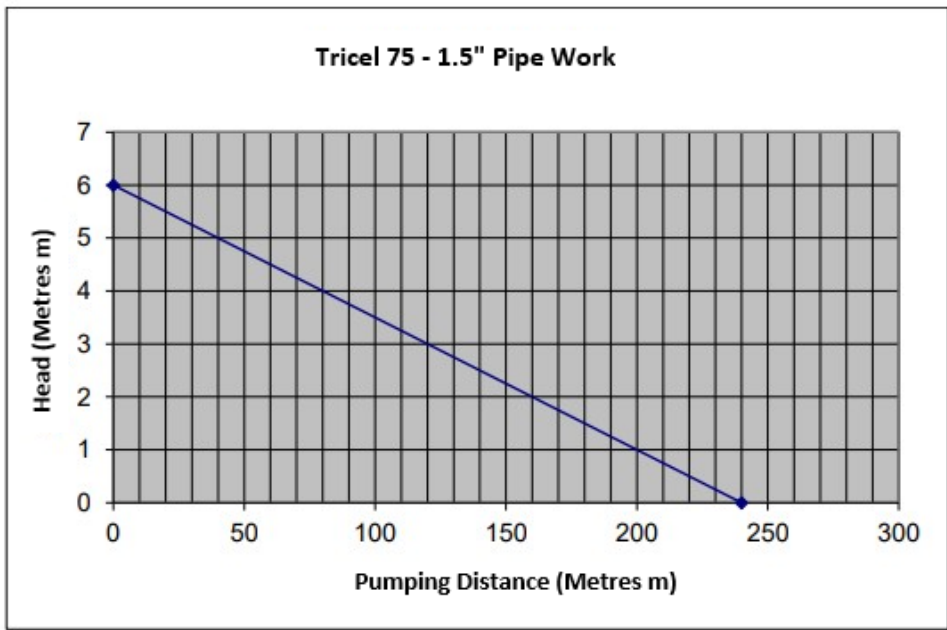

6.2 Domo GRI 11

The Domo GRI 11 is able to macerate all the solids present in the sewerage into small pieces. To operate correctly, make sure the on/off float of the pump can move freely and that it is not snagging against the divider or the side of a tank.

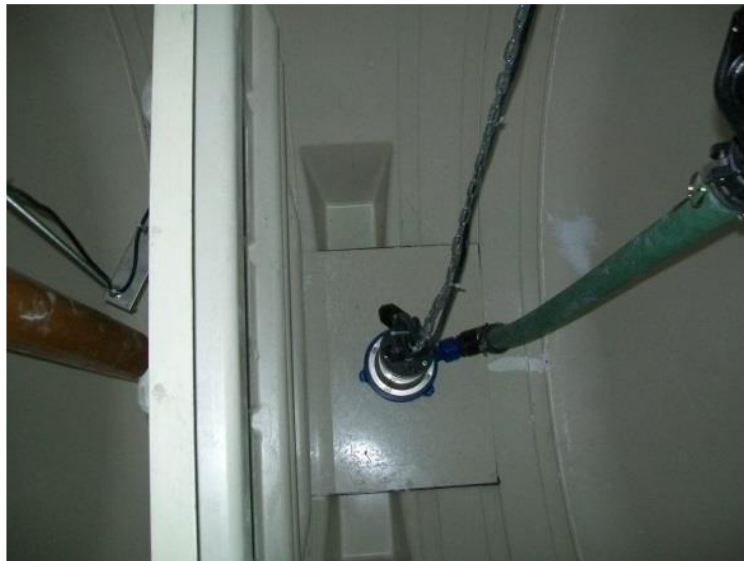

6.2.1 Operating Performance: GRI 11

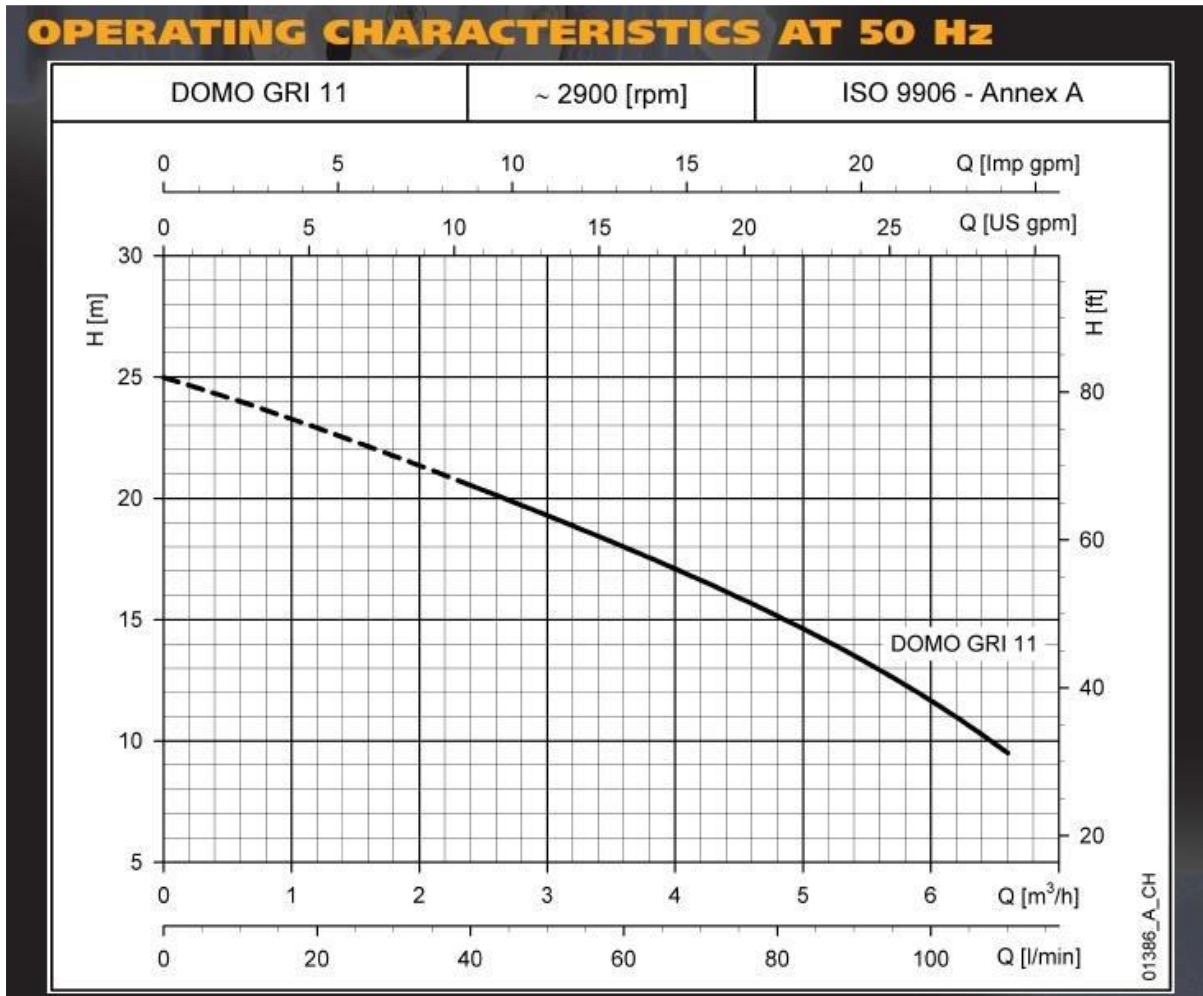

HYDRAULIC PERFORMANCE TABLE

PUMP TYPE	OUTPUT POWER		Q = DELIVERY											
			V _{min}	0	15	30	40	50	60	70	80	90	100	110
			m³/h	0	0,9	1,8	2,4	3	3,6	4,2	4,8	5,4	6	6,6
H = TOTAL HEAD METRES COLUMN OF WATER														
DOMO GRI 11 (SG)	1,1	1,5	25,0	23,5	21,7	20,5	19,3	18,0	16,6	15,2	13,5	11,7	9,5	
DOMO GRI 11 T														

These performances are valid for liquids with density $\rho = 1,0 \text{ kg/dm}^3$ and kinematic viscosity $\nu = 1 \text{ mm}^2/\text{s}$. domo-gri-2p50-en_a_th

ELECTRICAL DATA

PUMP TYPE	INPUT POWER*	INPUT CURRENT*	CAPACITOR
SINGLE-PHASE		220-240 V	
	kw	A	$\mu\text{F} / 450 \text{ V}$
DOMO GRI 11 (SG)	1,58	7,02	30

SG = without float
T = 3 Phase

PUMP TYPE	INPUT POWER*	INPUT CURRENT*	INPUT CURRENT*
THREE-PHASE		220-240 V	380-415 V
	kw	A	A
DOMO GRI 11 T	1,49	4,73	2,73

*Maximum value in specified range domo-gri-2p50-en_a_te

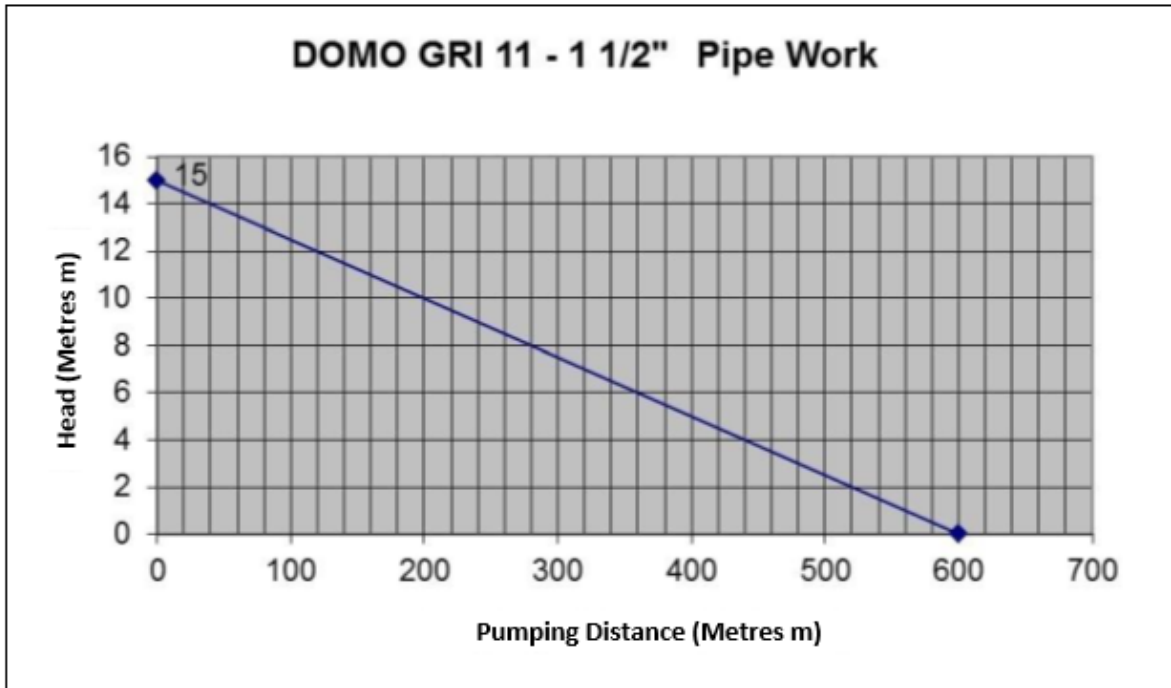

6.3 High-Level Float

The high-level float is a safety feature installed in the tank. If the pump fails, the tank will fill with sewerage thus raising the high-level float which activates a beeping alarm and red light. If the alarm is activated, the home owner should contact Tricel to send out a technician with a replacement pump. To operate correctly, make sure the float can move freely and that it is not snagging against the side of a tank.



6.4 Non-Return Valve

The non-return valve is used to prevent the wastewater flowing back into the tank when the pump switches off. The non-return valve consists of two components, a plastic housing and spring-loaded flap. When the pump switches off, the spring-loaded flap closes, blocking the pipe preventing waste water returning back into the tank. When the pump switches on, the force of the water opens the spring-loaded flap and allows the water to flow through the pipe.



7 Plant Operation

Once tank installation, plumbing and the electrical connection are complete, the Tricel Pumping Chamber is now operational. The plant should be already filled with water during installation before its first use. If the plant is running correctly, once the power supply is turned on, the pump will operate, pumping the water out of the tank until the water level reaches the off position of the pump float.

Once the Tricel Pumping Chamber is installed and operational, it is important that it's commissioned by our service team or a Tricel Pumping Chamber distributor to ensure it is working effectively. A commissioning certificate will then be issued to the customer.

All plants are fitted with an alarm, which will alert of irregularities in the system.

8 Disposal of Treated Water

The water discharged from Tricel Pumping Chamber should be disposed of as per guidelines from the planning regulations issued by your local authority.

9 Maintenance

Warning

Any maintenance carried out inside the tank represents a confined space. Therefore, the maintenance person must be suitably trained to work in confined spaces. Sewage and sewage effluent can carry micro-organisms and gases harmful to human health. Any person carrying out maintenance on the plant must be appropriately trained. Suitable protection equipment including gloves, goggles etc. should be worn at all times. Always remove contaminated clothing and protective equipment after completion of work. Wash hands and face prior to eating, drinking or smoking. Refer to Section 1.

A certain amount of maintenance is required on an on-going basis to ensure that the pumping chamber is working correctly. This is the responsibility of the customer.

9.1 Regular Maintenance

- All vents should be checked to make sure they are not blocked or obscured.
- The vent under the de-sludging cover allows gas to escape and stops the tank from becoming pressurized.
- The non-return valve must be checked for blockages.
- The inlet and outlet should be inspected and rodded to remove any blockages if necessary.

9.2 Annual Maintenance

- Service personnel must be accommodated with clear access to the tank.

9.3 Annual Service (Available from your supplier)

During routine servicing, the service technician will perform a series of checks and procedures:

Checks

- The covers and locks are in place and in good condition.
- General appearance and condition of the pumping chamber is good.

Procedures

- The high-level alarm is tested.
- The non-return valve is tested.
- The pump and float-switch are tested.
- The vents are cleared of any blockages.

9.4 De-sludging (Emptying the solid waste from the pumping chamber)

Important

- The de-sludging of the Tricel Pumping Chamber is the responsibility of the customer. De-sludging should never be carried out alone.
- Do not allow machinery/traffic drive over the plant. Maintain a distance of at least 4 metres away from the covers on the Tricel Pumping Chamber.
- The access covers should never be left off an unattended Tricel Pumping Chamber.

When the **pump fails** de-sludging/emptying is required. De-sludging is done with a vacuum tanker (Tricel recommend the use of a licensed company). Get the desludging company to give the pumping chamber a wash out with a water hose and suck this dirty water out. Wash grease/fat/dirt off the floats and pumps. Contact the Tricel service team to replace the pump.

- Remove any de-sludging access covers/cap.
- Empty the Tricel Pumping Chamber using the vacuum tanker. Ensure the solids are removed with the liquid.
- Care must be taken not to damage the Tricel Pumping Chamber with the hose of the vacuum tanker.
- Replace the de-sludging access covers/cap securely.

10 Operating Conditions

Warning

Tricel shall not be liable for any damage or loss, including consequential loss, caused by the failure of any plumbing equipment or failure caused by the inclusion of prohibited material, in the pumping chamber.

The manufacturer's installation, operation and maintenance instructions outlined in this manual must be followed at all times to ensure the pumping chamber operates as designed. Any variations to these conditions could result in the unit not performing to its full potential and the discharge may not meet the required standards. The property owner has a legal responsibility to ensure that the pumping chamber does not cause pollution, a health hazard or nuisance.

10.1 Conditions

- An electrical connection to the Tricel Pumping Chamber must be maintained for it to function correctly. This ensures that the discharge pump will operate.
- The Tricel Pumping Chamber includes many components (plumbing, ventilation, pump and alarm/control box). Each component has to function correctly for the overall system to work which is the responsibility of the homeowner.
- If the Tricel Pumping Chamber is not installed correctly, flooding, overloading, electrical shock or floatation may occur. Tricel are not responsible for incorrectly installed pumping chambers.
- Damage to the installation due to the influx of surface water or the backing up of soak ways or drains is not covered by the Tricel.
- To ensure the continuance of the Tricel Pumping Chamber's performance, the user has to take certain precautions:

- The design loading of the Tricel Pumping Chamber should not be exceeded.
- High volume discharges such, as those from swimming pools and Jacuzzi's must never enter the Tricel Pumping Chamber.
- Surface water must not enter the Tricel Pumping Chamber.
- Do not allow the following to enter the Tricel Pumping Chamber:
 - Oil or Grease
 - Babywipes, cosmetic and cleaning wipes
 - Sanitary towels
 - Tampons
 - Kitchen paper
 - Nappies
- Service personnel must be provided with clear access to the Tricel Pumping Chamber.
- If others size the Tricel Pumping Chamber, Tricel will supply to these specifications. In this case, the responsibility lies with others in relation to the maximum flow/litres per day, the Tricel Pumping Chamber capacity and retention times. Similarly, if Tricel size the Tricel Pumping Chamber and a greater load is placed on the Tricel Pumping Chamber by the addition of extra houses, bedrooms, schools, crèche's etc. or by other means Tricel are not responsible for the Tricel Pumping Chamber in terms of overloading or time to pump empty the chamber may be compromised.
- Should the Tricel Pumping Chamber be used intermittently or if extended periods of non-use are expected, it is recommended that the Tricel Pumping Chamber remain on and in operation. The contents of the pump chamber should not be allowed to go septic due to non-use. Water should be pumped into it twice a year to prevent to pump from seizing up.
- The tank is not suitable for vehicular traffic. Tricel also recommend fencing off the area to prevent livestock herds from accessing the Tricel Pumping Chamber.

11 Troubleshooting

Properly installed, operated and maintained pumping chambers will give many years of trouble free service. All pumping chambers are fitted with an alarm, which will alert of irregularities in the pumping chamber. If a pump stops working a buzzer will sound to indicate there is a problem with the pumping chamber. The buzzer can be muted until the problem is fixed. Once fixed, the alarm will reset automatically and the mute switch must be reset manually. All electrical work shall be carried out by a certified electrician.

11.1 Plant Operation

Symptom	Possible causes	Solution
Pump won't start or run	Fuse blown (if applicable).	Replace with fuse of suitable size.
	Tripped breaker.	Reset breaker.
	Low line voltage and wet electrics.	An electrician should check the power supply to the pumping chamber.
	Defective pump.	Pump must be checked by a qualified person.
Pumping chamber fills above working water level	Percolation Area/Polishing Filter clogged.	Contact installer to repair percolation area/polishing filter.
	Storm water flooding.	Redirect storm water drains. Storm water must never enter the pumping chambers.
	Discharge hose/pipe blocked.	Find blockage and remove or replace damaged hose/pipe.
	Pump has stopped working	Pump must be checked by a qualified person.
Pump operates but delivers no water	Low line voltage or wired incorrectly.	An electrician should check the power supply to the pump.
	Blockage in impeller.	Clean out impellers or replace pump. WARNING: Ensure the pump is disconnected from mains power supply before you attempt to unclog it.
	Delivery hose blocked.	Find blockage and remove or replace damaged hose.
Pump runs intermittently	Thermal overload tripped.	Check for clogged impeller WARNING: Ensure the pump is disconnected from mains power supply before you attempt to unclog it.
		The pump has run dry so add water.
	Float from the pump stuck.	Ensure the float on the pump is set correct and can move freely.
	Damaged float.	Pump must be checked by a qualified person.
Alarm is sounding but the pump is working	High-level float is snagged on something inside the tank in the 'On' position	Free the high-level alarm float; unsnag it inside the tank.
	Electrical fault.	Get a qualified person to check that the alarm is installed correctly.
	The electrical panel is wet.	Get a qualified person to check that the alarm is installed correctly.

Build-up of grease and fat particularly on the float switches and pumps	Build-up of grease and fat may happen over a long or short period of time depending on type of material entering the tank.	The float and pump may need to be withdrawn for hosing down. Once the pump and float has been cleaned, they will operate in a more efficient manner. Note: In applications in which a lot of grease/fat could enter the pumping chamber, a grease trap should be installed.
--	--	---

11.2 Odours

Symptom	Possible causes	Solution
Effluent odour directly outside the house or inside the house	Pipe connections to toilets / drains not connected correctly.	Check that the traps / U - bends in the drains are fitted and the joints sealed & contain water.
	Air vent on pipe work not fitted or fitted incorrectly on house.	Ensure all effluent pipes are vented correctly with vent stacks. Vents are normally fitted to all lines and they should be higher than the eave of the roof, as per building regulations.
	Pipe work is damaged or blocked or fitted incorrectly.	Inspect pipe work to ensure it is undamaged and clear of obstructions or sagging.
Bad effluent odour directly over the tank	Pipe work to or from the tank is blocked.	Check the level of liquid in the tank. Ensure the pipes are not blocked and are fitted correctly to the tank.
	Defective pump	Ensure pump is working properly.
	Tank vent blocked	Unblock tank vent

Note:

Before taking any corrective action, always positively identify the real source of the odour. Check if the odour is coming from another outside source such as a storm drain. All pumping chambers vent gases back through soil pipe and out roof vents. Improperly installed roof vents can cause odour problems. Traps in drains prevent odours from entering the home. To function they must contain water and be sealed correctly.

12 Terms & Conditions

Subject to our standard terms and conditions, which are available on request.

In accordance with our normal policy of product development, this specification is subject to change without notice. (November 2019)

Notes

Identification Code	This Tricel Pumping Chamber is:
TPCIE2600	
TPCIE4000	



Tricel (Killarney) Unlimited Company Trading as Tricel
 Ballyspillane Ind. Est. Killarney, Co. Kerry, Ireland
 Tel: +353 (0)64 663 2421 | Email: sales@tricel.ie | www.tricel.ie

Tricel Environmental UK, A trading brand of Dewey Waters Ltd.,
 Tricel Weston, Winterstoke Road, Weston-super-Mare, BS24 9AN, United Kingdom
 Tel: 44 (0) 1934 422 311 | Email: environment@tricel.co.uk | www.tricel.co.uk

In accordance with Tricel normal policy product development these specifications are subject to change without notice.